

2–40 hp Portable Chillers

Part Number: A0554832
Bulletin Number: SC2-610C.8
Effective: 11/01/03

Write Down Your Serial Numbers Here For Future Reference:

_____	_____
_____	_____
_____	_____

We are committed to a continuing program of product improvement.
Specifications, appearance, and dimensions described in this manual are subject to change without notice.

DCN No. _____
© Copyright 2004
All rights reserved.

Shipping Information

Unpacking and Inspection

You should inspect your equipment for possible shipping damage. Thoroughly check the equipment for any damage that might have occurred in transit, such as broken or loose wiring and components, loose hardware and mounting screws, etc.

In the Event of Shipping Damage

According to the contract terms and conditions of the Carrier, the responsibility of the Shipper ends at the time and place of shipment.

Notify the transportation company's local agent if you discover damage

Hold the damaged goods and packing material for the examining agent's inspection. **Do not return any goods before the transportation company's inspection and authorization.**

File a claim with the transportation company. Substantiate the claim by referring to the agent's report. A certified copy of our invoice is available upon request. The original Bill of Lading is attached to our original invoice. If the shipment was prepaid, write us for a receipted transportation bill.

Advise customer service regarding your wish for assistance and to obtain an RMA (return material authorization) number.

If the Shipment is Not Complete

Check the packing list as back-ordered items are noted on the packing list. In addition to the equipment itself, you should have:

- Bill of lading
- Packing list
- Operating and Installation packet
- Electrical schematic and panel layout drawings
- Component instruction manuals (if applicable)

Re-inspect the container and packing material to see if you missed any smaller items during unpacking.

If the Shipment is Not Correct

If the shipment is not what you ordered, **contact the shipping department immediately**. For shipments in the United States and Canada, call **1 (800) 783-7835**; for all other countries, call our international desk at **(414) 354-0970**. Have the order number and item number available. *Hold the items until you receive shipping instructions.*

Returns

Do not return any damaged or incorrect items until you receive shipping instructions from the shipping department.

Table of Contents

CHAPTER 1: SAFETY	6
1-1 How to Use This Manual	6
<i>Safety Symbols Used in this Manual</i>	6
1-2 Warnings and Precautions	7
1-3 Responsibility	7
CHAPTER 2: FUNCTIONAL DESCRIPTION.....	8
2-1 Models Covered in This Manual.....	8
2-2 General Description.....	9
<i>Chilled Water Circuit</i>	9
<i>Refrigeration Circuit</i>	9
2-3 Standard Features.....	10
<i>Mechanical Features</i>	10
<i>Electrical Features</i>	11
<i>Refrigeration Features</i>	11
<i>Controller Features</i>	11
<i>Other Features</i>	11
2-4 Safety Devices and Interlocks	12
<i>High/Low Thermostat Control</i>	12
<i>Crankcase Heater</i>	12
<i>High Pressure Cutout</i>	12
<i>Low Pressure Cutout</i>	13
<i>Oil Pressure Safety Switch</i>	13
<i>Fan Cycling Switch</i>	13
<i>Pressure Switch</i>	13
<i>Flow Switch</i>	13
<i>Remote Start/Stop Interlock</i>	13
2-5 Optional Features.....	14
CHAPTER 3: INSTALLATION	17
3-1 Uncrating.....	17
3-2 Electrical Connections.....	17
3-3 Process Water Connections.....	18
3-4 Bypass Valve Considerations.....	18
3-5 Galvanic Corrosion Considerations.....	18
3-6 Water Treatment Considerations	18
3-7 Condenser Considerations.....	19
<i>Water-Cooled Chiller Condensers</i>	19
<i>Air-Cooled Chiller Condensers</i>	19
<i>Remote Air-Cooled Chiller Condensers</i>	20
3-8 Checking Motor Direction	24
<i>Three-Phase Compressors</i>	24
<i>Water Pumps</i>	24
<i>Condenser Fan</i>	24
3-9 Water Reservoir	25
3-10 Automatic Water Make-Up Option.....	27

3-11	Initial Start-Up.....	28
CHAPTER 4: OPERATION		29
4-1	Panel Buttons, Indicator Lights, and Switches	29
	<i>Microprocessor Controllers</i>	29
	<i>Graphic Panel</i>	32
4-2	Start-up.....	35
4-3	Setting the Process Water Temperatures	35
4-4	Auto-Tuning.....	35
4-5	Optional Communications	35
4-6	Programming the Electronic High/Low Thermostat.....	36
CHAPTER 5: MAINTENANCE		38
5-1	Lubrication.....	38
5-2	Filter Cleaning	38
5-3	Maintaining the Condenser	39
	<i>Air- and Remote Air-Cooled Chillers</i>	39
	<i>Water-Cooled Chillers</i>	39
5-4	Maintaining the Evaporator	39
5-5	Evaporator Process Piping Y-Strainer.....	39
5-6	Preventative Maintenance Service.....	40
CHAPTER 6: TROUBLESHOOTING		41
CHAPTER 7: APPENDIX		43
7-1	Warranty.....	43
7-2	Technical Assistance.....	44
	<i>Parts Department</i>	44
	<i>Service Department</i>	44
	<i>Sales Department</i>	44
	<i>Contract Department</i>	44
7-3	Drawings and Specifications	45
	<i>2 hp and 3 1/2 hp Air-Cooled Portable Chillers</i>	45
	<i>5 hp and 7.5 hp Air-Cooled Portable Chillers</i>	46
	<i>10 hp and 15 hp Air-Cooled Portable Chillers</i>	47
	<i>20 hp, 25 hp, and 30 hp Air-Cooled Portable Chillers</i>	48
	<i>2 hp and 3.5 hp Water-Cooled Portable Chillers</i>	49
	<i>5 hp and 7.5 hp Water-Cooled Portable Chillers</i>	50
	<i>10 hp and 15 hp Water-Cooled Portable Chillers</i>	51
	<i>20 hp, 25 hp, and 30 hp Water-Cooled Portable Chillers</i>	52
	<i>35 hp and 40 hp Water-Cooled Portable Chillers</i>	53
	<i>5 hp and 7.5 hp Remote Air-Cooled Portable Chillers</i>	54
	<i>10 hp and 15 hp Remote Air-Cooled Portable Chillers</i>	55
	<i>20 hp through 40 hp Remote Air-Cooled Portable Chillers</i>	56
	<i>Remote Condenser Assembly Models</i>	57
7-4	Pump Curves, Flow, and Pressure Considerations.....	58
	<i>60 Hertz Pump Curves</i>	58
	<i>50 Hertz Pump Curves</i>	59
	<i>Water Pressure Drop Tables</i>	60

	<i>Flow and Pressure Considerations</i>	61
	<i>Recirculation Pump Specifications</i>	61
7-5	Remote Air-Cooled Chiller Configurations	62
7-6	Typical Ductwork for Air-Cooled Chillers	63
7-7	Piping Diagrams	64
	<i>Central and Gravity Return Piping with Standpipe Diagram</i>	64
	<i>Typical Piping Schematic, 2 and 3 1/2 hp Models</i>	65
	<i>Typical Piping Schematic, 5 hp through 40 hp, One-Pump Models</i>	66
	<i>Typical Piping Schematic, 5 hp through 40 hp, Two-Pump Models</i>	67
	<i>Typical Piping Schematic, 5 hp through 40 hp, No-Pump Models</i>	68
	<i>Typical Piping Schematic, 5 hp through 40 hp, One-Pump Models</i>	69
7-8	Electrical Schematics	70
	<i>Typical Electrical Subpanel</i>	70
	<i>Typical Electrical Schematic, 2 hp and 3 1/2 hp Models</i>	71
	<i>Typical Power Wiring Schematic, 5 hp through 40 hp Models</i>	72
	<i>Typical Wiring Schematic, 5 hp through 15 hp Models with Pump</i>	73
	<i>Typical Wiring Schematic, 5 hp through 15 hp Models without Pump</i>	74
	<i>Typical Wiring Schematic, 20 hp through 30 hp Models with Pump</i>	75
	<i>Typical Wiring Schematic, 20 hp through 30 hp Models without Pump</i>	76
	<i>Typical Wiring Schematic, 35 hp and 40 hp Models with Pump</i>	77
	<i>Typical Wiring Schematic, 35 hp and 40 hp Models without Pump</i>	78

Chapter 1: Safety

1-1 How to Use This Manual

Use this manual as a guide and reference for installing, operating, and maintaining your equipment. The purpose is to assist you in applying efficient, proven techniques that enhance equipment productivity.

This manual covers only light corrective maintenance. No other maintenance should be undertaken without first contacting a service engineer.

The Functional Description section outlines models covered, standard features, and optional features. Additional sections within the manual provide instructions for installation, pre-operational procedures, operation, preventive maintenance, and corrective maintenance.

The Installation chapter includes required data for receiving, unpacking, inspecting, and setup of the equipment. We can also provide the assistance of a factory-trained technician to help train your operator(s) for a nominal charge. This section includes instructions, checks, and adjustments that should be followed before commencing with operation of the equipment. These instructions are intended to supplement standard shop procedures performed at shift, daily, and weekly intervals.

The Operation chapter includes a description of electrical and mechanical controls, in addition to information for operating the equipment safely and efficiently.

The Maintenance chapter is intended to serve as a source of detailed assembly and disassembly instructions for those areas of the equipment requiring service. Preventive maintenance sections are included to ensure that your equipment provides excellent, long service.

The Troubleshooting chapter serves as a guide for identification of most common problems. Potential problems are listed, along with possible causes and related solutions.

The Appendix contains technical specifications, drawings, schematics, and parts lists. A spare parts list with part numbers specific to your machine is provided with your shipping paperwork package. Refer to this section for a listing of spare parts for purchase. Have your serial number and model number ready when ordering.

Safety Symbols Used in this Manual

The following safety alert symbols are used to alert you to potential personal injury hazards. Obey all safety messages that follow these symbols to avoid possible injury or death.

Danger! *DANGER indicates an imminently hazardous situation which, if not avoided, will result in death or serious injury.*

Warning! *WARNING indicates a potentially hazardous situation or practice which, if not avoided, could result in death or serious injury.*

Caution! *CAUTION indicates a potentially hazardous situation or practice which, if not avoided, may result in minor or moderate injury or in property damage.*

1-2 Warnings and Precautions

Our equipment is designed to provide safe and reliable operation when installed and operated within design specifications, following national and local safety codes.

To avoid possible personal injury or equipment damage when installing, operating, or maintaining this equipment, use good judgment and follow these safe practices:

- ☑ Follow all **SAFETY CODES**.
- ☑ Wear **SAFETY GLASSES** and **WORK GLOVES**.
- ☑ Disconnect and/or lock out power before servicing or maintaining the equipment.
- ☑ Use care when **LOADING, UNLOADING, RIGGING, or MOVING** this equipment.
- ☑ Operate this equipment within design specifications.
- ☑ **OPEN, TAG, and LOCK ALL DISCONNECTS** before working on equipment. You should remove the fuses and carry them with you.
- ☑ Make sure the equipment and components are properly **GROUND**ED before you switch on power.
- ☑ When welding or brazing in or around this equipment, make sure **VENTILATION** is **ADEQUATE. PROTECT** adjacent materials from flame or sparks by shielding with sheet metal. An approved **FIRE EXTINGUISHER** should be close at hand and ready for use if needed.
- ☑ Refrigeration systems can develop refrigerant pressures in excess of 500 psi (3,447.5 kPa/ 34.47 bars). **DO NOT CUT INTO THE REFRIGERATION SYSTEM. This must be performed by a qualified service technician only.**
- ☑ Do not restore power until you remove all tools, test equipment, etc., and the equipment and related components are fully reassembled.
- ☑ Only **PROPERLY TRAINED** personnel familiar with the information in this manual should work on this equipment.

We have long recognized the importance of safety and have designed and manufactured our equipment with operator safety as a prime consideration. We expect you, as a user, to abide by the foregoing recommendations in order to make operator safety a reality.

1-3 Responsibility

These machines are constructed for maximum operator safety when used under standard operating conditions and when recommended instructions are followed in the maintenance and operation of the machine.

All personnel engaged in the use of the machine should become familiar with its operation as described in this manual.

Proper operation of the machine promotes safety for the operator and all workers in its vicinity.

Each individual must take responsibility for observing the prescribed safety rules as outlined. All warning and danger signs must be observed and obeyed. All actual or potential danger areas must be reported to your immediate supervisor.

Chapter 2: Functional Description

2-1 Models Covered in This Manual

This manual provides operation, installation, and maintenance instructions for air- and water-cooled portable chillers. Model numbers are listed on the serial tag. Make sure you know the model and serial number of your equipment before contacting the manufacturer for parts or service.

Our portable chiller models are designated by approximate compressor horsepower (2, 3 1/2, 5, 7 1/2, 10, etc) and the cooling method used: -A for air-cooled, -W for water-cooled, and -R for remote-air cooled.

2-2 General Description

Our portable chillers are reliable, accurate, and easy to use process cooling units. They are available in air-, water-, and remote air-cooled designs in a range of sizes from 2 to 40 tons. All are self-contained, fully portable and shipped ready to use. (Remote air-cooled chillers require field installation by qualified technicians.)

Standard range of operation is 30°F to 65°F (-1°C to 18°C) for applications using a water/glycol mix and 45°F to 65°F (7° to 18°C) for water only applications.

A factory installed crankcase pressure regulating valve option is available for processes requiring a leaving water temperature of up to 75°F (24°C).

Chilled Water Circuit

Cooling water “To Process” and “From Process” connections are made at the gate valves provided outside the unit. Warm coolant (water and glycol mixture) returns from the process and goes into the reservoir tank. The coolant is then pumped through the evaporator where it is cooled. The coolant flows to the process and returns to repeat the cycle.

A pressure actuated process water bypass valve located between the supply line and reservoir tank (single pump models only) allows minimal flow through the unit during the intermittent fluctuating flow conditions. It is not intended to provide continuous full bypass flow.

This minimal flow allows the temperature sensor to signal the controller to shut down the compressor because of the drop in process water temperature. Typically the flow switch shuts down the chiller in this low flow condition.

The 2 hp and 3 1/2 hp models have a 1/4” poly-tubing constant bypass to provide additional process water bypass to prevent system freeze-up.

Refrigeration Circuit

Air-, water-, and remote air-cooled refrigerant condensing differs only in the way the compressed gas is condensed to a liquid.

Liquid refrigerant from the condenser heat exchanger flowing in the liquid line passes through a shut-off valve (5 hp to 40 hp chillers only) into a filter/dryer that removes moisture and other contaminants. A refrigerant sight glass is provided. The refrigerant then passes through the thermal expansion valve, which allows the refrigerant to expand (boil off) and cool the fluid inside of the evaporator. The refrigerant gas flows through the suction line back into the compressor.

The refrigerant is compressed in the compressor and flows through the discharge line as a gas to the condenser. There it gives up its heat as it condenses to a liquid in the condenser.

A hot gas bypass valve is used to control cooling capacity during intermittent or partial load conditions. This feature contributes substantially to chiller longevity by eliminating excessive cycling of the compressor and providing close temperature control.

2-3 Standard Features

Mechanical Features

Compressor. Hermetic scroll compressors are used on 2 hp through 30 hp (1.49 through 23.37 kW) models. Semi-hermetic discus compressors are used on the 35 hp and 40 hp (26.20 and 29.83 kW) models.

Evaporator. Stainless steel copper brazed plate evaporators are used on 2 hp through 30 hp models. Shell and tube evaporators are used on the 35 hp and 40 hp models.

Air-Cooled Condenser. Aluminum fin/copper tube with washable filters, *package unit only*.

Water-Cooled Condenser. 2 hp to 7.5 hp models use tube-in-tube condensers. 10 hp to 40 hp use cleanable shell and tube condensers. All come with cooling water regulating valves for cooling tower water or city water.

Remote Air-Cooled Condenser. 5 hp to 50 hp only. Aluminum fin/copper tube with low ambient control down to -20°F (-29°C) via pressure-actuated fan staging and a variable-speed primary fan.

Reservoir. 2 hp and 3 1/2 hp models use a 6 gallon polyethylene tank. 5 hp and 7.5 hp models use a 20 gallon polyethylene tank. 10 hp and 15 hp models use a 40 gallon polyethylene tank. 20 hp to 30 hp models use an 80 gallon polyethylene tank, and 35 hp and 40 hp models use an 80 gallon stainless steel tank.

Piping. Non-ferrous piping for 2 hp through 30 hp models. 35 hp and 40 hp models have ferrous piping.

Pump. Non-overloading ODP motors, horizontally mounted stamped stainless steel or cast bronze construction.

Other Mechanical Features

- External fill/drain sight glass
- Low process water pressure switch on 2 hp and 3 1/2 hp models
- Low process water flow switch on 5 hp to 40 hp models
- Galvanized steel mounting rails for remote air-cooled models
- NEMA-rated fan motor(s) on air-cooled models
- Galvanized structural steel frame, painted cabinetry, with 2 1/2" swivel casters on 2 hp and 3 1/2 hp models. 4" swivel casters on 5 hp to 15 hp models, and 5" swivel casters with brake on 20 hp to 40 hp models.
- Valved process water connections
- Pressure-actuated process water bypass valve for system protection only; on single pump models only
- To process 2 1/2" dual scale liquid-filled water pressure gauge
- Fully insulated refrigeration and process water piping
- Isolated fan section on air-cooled models, allowing chiller to run during maintenance
- 20 mesh Y strainer on process water piping into the evaporator

Electrical Features

- Fully accessible NEMA 12-style electrical control enclosure
- Single-point power and ground connection
- Non-fused disconnect switch, lockable
- Branch circuit fusing
- 208-230/3/60 and 460/3/60 volt (consult factory for other voltages)
- 208-230/1/60 volt on 2 and 3 1/2 hp models

Refrigeration Features

- R-22 refrigerant
- Hot gas bypass capacity control
- High discharge temperature cutout on 2 hp to 30 hp models
- High and low refrigerant pressure cutout switches
- Fan cycling switch (5 hp to 30 hp air-cooled models only)
- High pressure spring actuated relief valve
- Multiple refrigeration access ports
- Compressor service valves
- Hot gas bypass and liquid line shut-off ball valves on 5 hp to 40 hp models
- Filter-dryer
- Sight glass
- Balanced port thermal expansion valve

Controller Features

- Off-the-shelf microprocessor-based PID auto-tuning controller with To Process and Set Point LED readout
- Microprocessor temperature switch with LCD display for process water freeze protection compressor cutout, and high process water temperature pump cutout
- Electronic time delay for proof of water flow/pressure (models w/pump only)
- Off-delay water flow timer to prevent short cycling (models w/pump only)
- Low refrigerant pressure switch, override timer for low ambient start-up on remote air-cooled and air-cooled chillers with the variable-speed fan option.
- Graphic control panel with indicating and warning status lights

Other Features

- One year labor warranty and one year compressor warranty
- Two year parts warranty

- Three year limited controller warranty

2-4 Safety Devices and Interlocks

High/Low Thermostat Control

The high/low thermostat is a cutout device that protects the chiller system in two ways. Stage one of the thermostat shuts down the compressor if the chilled process water/glycol temperature approaches the particular mixture's freezing point. The chilled process water/glycol pump will continue to run.

The high/low thermostat stage one cutout temperature is factory-set at 42°F (5.5°C). This is correct for a supply water temperature of 50°F (10°C), the rated capacity operating temperature. If you want lower chilled water temperatures, mix process water with glycol to provide protection down to 20°F (11°C) below the operating "To Process" temperature you want. You can then reset the high/low thermostat cutout temperature to a temperature 8°F (4.4°C) below the operating temperature you want.

Stage two of the high/low thermostat shuts down the pumps, therefore shutting off the chiller, if the chilled process water/glycol temperature rises above the selected cutout point. This prevents possible damage to the complete process piping system due to overheating of the components by the process water/glycol. The thermostat stage two cutout temperature is factory set at 100°F (38°C). See Section 4-6 on page 36 for information about changing the thermostat settings.

Caution! *Protect the system from freezing with glycol 20°F below the leaving water temperature set point. Condensation may form inside the pump tank and dilute the mixture, therefore the freezing point should be verified periodically. See Figure 6 on page 26 for the correct mixture.*

Caution! *Set high/low thermostat cutout temperature 8°F below the set point leaving water temperature.*

Crankcase Heater

5 hp through 40 hp portable chillers have a crankcase heater. It is wired through the control transformer that operates continuously whenever power is applied to the chiller.

Caution! *Energize the crankcase heater for at least 24 hours before initial startup to drive dissolved refrigerant from the compressor oil. Failure to do so will damage the compressor.*

High Pressure Cutout

This electro-mechanical cutout device opens the compressor control circuit if the refrigeration system compressor discharge pressure exceeds 375 psi for an air-cooled chiller and 290 psi for a water-cooled chiller.

Note: *The high-pressure cutout is a manual reset device typically mounted on the compressor discharge line inside the mechanical cabinet. Call a refrigeration service technician to analyze the problem and reset the control.*

Low Pressure Cutout

This electro-mechanical cutout device opens the compressor control circuit if refrigeration system compressor suction pressure drops below 15 psi. It automatically resets when refrigerant suction pressure reaches 30 psi.

Note: *The low pressure cutout is an automatic reset device typically mounted on the compressor suction line inside the mechanical cabinet. Call a refrigeration service technician to analyze the problem and reset the control.*

Oil Pressure Safety Switch

This mechanical cutout device is installed on chillers built with semi-hermetic compressors that have oil pumps. A differential pressure switch monitors the difference between crankcase pressure and oil pump pressure.

If the pressure drops to an unsafe level for more than two minutes, the switch opens the control wiring circuit, shutting off the compressor and turning the light on, but the pumps will continue running.

Note: *The oil pressure safety switch is a manual reset device. Call a refrigeration service technician to analyze the problem and reset the control.*

Fan Cycling Switch

Air-cooled models only. 5 hp and 7.5 hp models have one fan. The fan cycling switch turns on the fan when the discharge pressure in the condenser reaches 300 psi and turns it off when the pressure drops below 190 psi.

10 hp to 30 hp models have two fans. One fan runs continuously every time the compressor operates. The second fan turns on when the discharge pressure in the condenser reaches 275 psi and turns off when the pressure drops below 200 psi.

Pressure Switch

2 hp and 3 1/2 hp models have a pressure switch cutout device mounted in the process piping. The switch shuts down the chiller if it senses that the water/glycol pressure through the evaporator has dropped below an acceptable level. The pressure switch opens the control circuit, shuts down the pumps, and shuts off the chiller.

Flow Switch

5 hp to 40 hp models only. The flow switch cutout device, mounted in the process piping, shuts down the chiller if it senses that the water/glycol flow rate through the evaporator has dropped below an acceptable level. The flow switch opens the control circuit and shuts down the pumps and the chiller.

Remote Start/Stop Interlock

An additional contact is provided to allow the remote starting or stopping of the chiller. To use this feature, remove the jumper between terminals X1 and 1, and supply a switch or dry contact interlock connected in series between these two terminals. Refer to the schematic inside the control enclosure door.

2-5 Optional Features

Options marked with “*” indicate options that can be factory installed or retrofitted in the field.

Automatic Water Make-Up*. Not available on chillers less reservoir tank. Includes a pressure-regulating valve set at 3 to 5 psi, an electric water solenoid valve, a float switch mounted in the reservoir tank, and the necessary internal piping to connect the chiller to a make-up water source. See Appendix for typical piping diagrams.

Caution! *Customer piping must provide backflow protection and venting of tank to atmosphere to prevent over-pressurization of the reservoir tank. See Central and Gravity Return Piping with Standpipe Diagram on page 64.*

Process Water Sidestream Filter*. Not available on chillers less pump and reservoir tank. Includes a 50 micron filter, flow meter, ball valve for throttling water flow, and the necessary piping to provide constant filtering of the process water at about one gallon per minute (1 gpm/3.8lpm).

General Fault Indicator Audible Alarm*. Includes an 85 dB @ 2 ft. audible alarm buzzer and silence button with provisions for customer wiring indication interlock. The alarm signals anytime that a fault is recognized during the operation of the chiller.

General Fault Indicator Audible/Visual Alarm*. Includes a 100 dB @ 10 ft. audible alarm horn/ 108,000 peak candlepower 80-flash/min. visual alarm strobe and silence button with provisions for customer wiring indication interlock. The alarm signals anytime that a fault is recognized during the operation of the chiller.

Compressor Hour Meter*. Includes a DIN-mount hour meter that keeps track of the total time that the compressor runs.

Communications Options. RS-232C and RS-485 communications standards are available.

Recirculation Pump. Necessary whenever process water flow is less than 2.2 gpm per ton (8.3 lpm per 3.517 kW) or greater than 4.8 gpm per ton (18.2 lpm per 3.517 kW).

High Pressure Fans. Provides for an additional 0.30”WC (75 pa) of static pressure on fan discharge. High-pressure fans are necessary and must be included in chiller installations where exiting air exhausts through ductwork.

The fans are available on 5 to 15 hp air-cooled chillers. They can be retrofitted without sheet metal modification, but will require changing out fan blades, and in some cases, fan motors and electrical components. 20 hp to 30 hp models come standard with squirrel cage blowers, which can be ducted.

Variable Speed Fan. Available on 5 to 15 hp air-cooled chillers. Reduces the speed of the fan based on entering air temperature and system load, allowing the chiller to operate in ambient temperatures below 60°F (15.5°C). This option will also reduce fan noise in ambients below 95°F (35°C).

Crankcase Pressure Regulating (CPR) Valve. Required on chillers operating at leaving water temperatures from 66°F to 75°F (10°C to 24°C). This valve prevents compressor motor overloading.

Stainless Steel Reservoir. 5 hp to 30 hp models only (Standard on 35 hp and 40 hp models). Manufactured from 304 stainless steel.

Mounting Features.

- Locking 5” swivel casters with brake, optional on air- and water- cooled 5 hp to 15 hp models
- Mounting rails: standard on remote air-cooled models, optional on other models
- Mounting rails with feet

Optional Operating Voltages. 380/3/50 volt available on 5 hp to 40 hp models only. Consult factory for other voltages

UL Labeled Electrical Subpanel. Provides for the subpanel to be listed with Underwriters Laboratory, with UL-related benefits and features.

Optional Pumps. Pump options are available for greater pressure and flow rates. A recirculation pump is required whenever process water flow is less than 2.2 gpm per ton or greater than 4.8 gpm per tone. See Figure 1 on page 16 for optional pump amperages.

NEMA 12 Electrical Enclosure. 5 hp to 40 hp models only. Provides for NEMA 12-level electrical enclosure protection. Includes an accessible protective window kit over the graphic control panel.

NEMA 12 Control Access Door. Includes an accessible protective window kit over the graphic control panel.

Figure 1: Optional Pump Amperages

Voltage	Construction	HP	Full Load Amps
208-230/1/60	Bronze Turbine	.75	5.4
	SS	1	6.4
		1.5	7.5
		2	9.6
		3	12.7
460/3/60	Bronze Turbine	.75	1.5
	SS	1	1.8
		1.5	2.3
		2	3.1
		3	4.2
		5	6.2
		7.5	9.8
		10	13.2
		15	19.0
	Dual SS	2	2.7
		3	4.5
		5	6.6
		7.5	9.0

Chapter 3: Installation

3-1 Uncrating

2 hp to 5 hp models are shipped mounted on a skid, enclosed in a plastic wrapper, and contained in a cardboard box. 7.5 to 40 hp models are shipped mounted on a skid, enclosed in a plastic wrapper, and open-crated on all four sides and top.

1. Pry the crating away from the skid.

Note: *2 to 5 hp models: remove the nails holding the box to the skid and lift the box off carefully, avoiding staples in the 1' x 4' wood supports. Cut the steel banding.*

2. Use a pry bar to remove the blocks securing the unit to the skid.
3. Lift unit from sides, inserting forklift under the base. The forks must be equidistant from the centerline of the unit and the unit must be balanced on the forks. (20 hp to 40 hp units feature special lifting openings.) Lift slowly and only high enough to clear the skid. Use a pry bar if necessary to carefully remove the skid from the unit.
4. Lower slowly. The unit should land on its casters or rails and can then be moved into position.
5. Temporary hardware has been installed to prevent side panels from shifting in transit. Remove hardware.
6. Retain the crating material for reshipping the chiller in case hidden shipping damage is found.

Caution! *Never remove the unit from the front (electrical control end) or the rear (pipe connection end). Damage may result.*

3-2 Electrical Connections

Supply electricity of the voltage, phase, and cycle listed on the serial tag. Total running amps are also found in the specification tables on pages 45-57 in the Appendix.

Bring properly sized power leads and ground from a fused disconnect (installed by your electrician) to the unit. Use dual-element fuses in the disconnect switch, sized according to the National Electrical Code recommendations. Note the outline drawings for egress into the cabinet. Make sure all electrical connections are tight.

Typical wiring schematics are located on pages 70-78 in the Appendix.

Warning! *Make sure that electrical connections comply with all applicable electrical codes. Ground the chiller in accordance with NEC Article 250.*

*Operation voltage must be within plus or minus 10% of the nameplate rating.
Phase imbalance must be below 10%*

3-3 Process Water Connections

All of our portable chillers have two chilled water connections. The chilled water supply, labeled “To Process” is the outlet for the chilled water leading to the process being cooled. The chilled water return, labeled “From Process” is the inlet leading from the process back into the chiller to be cooled and re-circulated.

All external chilled water connections should be run full size to the process. Flow and pressure information is available on pages 58-61 in the Appendix. The largest possible openings and passages should be provided for the flow of chilled water through platens, dies, molds, or other pieces of equipment.

Note: *Be sure to reduce external pressure drop as much as possible by generously sizing piping and tooling water passageways.*

3-4 Bypass Valve Considerations

Our portable chillers have a spring-loaded bypass valve. If the chilled water shut-off valves are inadvertently closed while the chiller is running, the factory-set bypass valve opens and allows a small amount of water to flow through the chiller. This action protects the chiller from freeze-up and allows the other cutout devices to shut down the chiller. The bypass valve is not intended to provide continuous full bypass flow.

Caution! *Do not attempt to adjust or otherwise tamper with the bypass valve. Your warranty will be voided.*

3-5 Galvanic Corrosion Considerations

The materials used in the water circuit piping of these chillers are non-ferrous and react electro-chemically with ferrous metallic materials. Some water has dissolved minerals that greatly accelerate the reaction between dissimilar metals.

PVC or non-ferrous piping is recommended to reduce galvanic action. If iron piping must be used, use dielectric unions at the chiller.

3-6 Water Treatment Considerations

Water treatment is an integral part of the system. In some locations, water may cause large deposits of scale, erosion, algae, and/or corrosion.

The use of poor quality water may result in inefficient operation, heat exchanger damage, and pump seal damage. Consult a qualified water treatment specialist to determine whether treatment is needed.

We offer a complete line of water treatment equipment. Contact your sales representative for water testing and treatment options.

3-7 Condenser Considerations

Water-Cooled Chiller Condensers

Water-cooled portable chillers can use city water or tower water as a cooling medium. Make sure that all external piping and connections supplying and discharging water to and from the condenser are full size.

You'll make two connections to the water-cooled condenser:

Condenser Water In. The condenser water supply, labeled "Condenser Water In", is located at the rear of the chiller. It is the inlet for city or tower water.

Make sure that water is supplied at a maximum temperature of 85°F (29°C) and a minimum pressure of 25 psi.

Caution! *The water-regulating valve is set at the factory. Only a qualified refrigeration technician should adjust it.*

Normal R-22 refrigerant condensing pressure is 210 psi, with 85°F (27°C) water at 25 psi entering condenser water pressure

Condenser Water Out. Condenser water return, labeled "Condenser Water Out", is located at the rear of the chiller. It is the outlet for water after it has passed through the condenser.

It is connected to the tower inlet or to a sewer or other approved discharge receiver. A water-regulating valve is a standard feature in the condenser water return line.

Air-Cooled Chiller Condensers

Air-cooled chillers use the surrounding air to cool the condenser. Install the chiller in an area where there is free passage of air for condensing and provisions for removal of heated air from the area. Do not locate air-cooled chillers in locations where steam, hot air, or fume exhausts can be drawn into the chiller. A typical ductwork diagram is located on page 63 in the Appendix of this manual.

Caution! *Clean air-cooled condensers and filters frequently. Failure to do so results in reduced capacity, increased operating costs, and possible failure of the equipment. Cleaning instructions can be found on page 38 in the Maintenance chapter of this manual*

Normal maximum refrigerant condensing pressure with 95°F (35°C) air entering the condenser is 260 psi.

Condensing Air Temperature. Our air-cooled portable chillers are designed to operate at a minimum condenser entering air temperature of approximately 60°F (15.5°C). Operation of the equipment at a lower condenser entering air temperature can cause the chiller to lose capacity. For entering air temperatures below 60°F, an optional fan motor speed control is available. We recommend maintaining a minimum 60°F ambient temperature.

Remote Air-Cooled Chiller Condensers

Remote air-cooled portable chillers are shipped with nitrogen holding charge and a full charge of oil (excluding the amount needed for field piping). The remote air condenser is shipped with a dry air charge. Verify that the holding charge has not been lost prior to installation. If there is no pressure, leak test the unit and repair before installing the interconnecting refrigerant piping. Read this entire section before installation.

Note: *Piping should be type “L” or type “K” refrigerant grade copper tubing only. Proper sizing and installation has a significant effect on system performance, reliability, and safety.*

Interconnecting Refrigerant Piping. The chiller and condenser refrigerant lines are terminated with a cap and brazed closed. Use a tube cutter to remove caps.

Caution! *Do not use a saw to remove the end caps because this will allow copper chips to contaminate the system.*

A certified refrigeration contractor need only to install the interconnecting refrigerant piping between the chiller and the outdoor air-cooled condenser. This piping must be properly sized, type “L” or type “K” refrigerant grade tubing, high temperature brazed, Install a customer supplied 400 psi approved refrigerant relief valve in the discharge line at the condenser, following all codes.

When brazing copper joints, flow dry nitrogen through the system to prevent carbon/scale formation, which causes contamination. Isolate the refrigerant lines from the building, preventing transfer of line vibration to the structure. Do not secure the lines rigidly.

Leak check and evacuate the system down to 400 microns. A decay of 50 microns after one hour is acceptable.

Warning! *To prevent injury or death due to explosion and/or inhalation of phosgene gas, purge system thoroughly while brazing refrigerant piping connections. Use a pressure regulator in the line between the unit and the high-pressure nitrogen cylinder to avoid over-pressurization and possible explosion.*

System Configuration. The system can be configured in any of the arrangements shown on page 62 of the Appendix. The configuration and distance between the chiller and the condenser affects pipe size, refrigerant charge, oil return, and oil charge. Therefore there are limitations that must be adhered to for reliable and optimal operation.

- Leaving water temperature affects discharge line size. Be sure to inform the installing contractor of the leaving water temperature range in which the chiller will be operating
- The total distance between the chiller and condenser must not exceed 200 feet or 300 equivalent pipe feet
- Discharge line risers cannot exceed an elevation difference greater than 100 feet without a 2% efficiency decrease.
- Refer to page 62 of the Appendix for the location of traps.
- Refrigeration lines must not be crossed, i.e., chiller liquid lines are to be piped to condenser liquid lines.

Sizing Refrigerant Lines. To determine field installed liquid and discharge line sizes, first establish the equivalent length of pipe for each line, valve, and elbow. Chiller capacity and leaving water temperature range is also required. See Figure 2 on page 22 for lengths of refrigerant valves and fittings.

Liquid Line Sizing. The liquid line should be sized as small as possible while maintaining acceptable pressure drop to minimize the refrigerant charge. Liquid line risers must not exceed 15 feet from the base of the air-cooled condenser. Horizontal runs do not require a pitch. Insulation is not required unless the line is installed in a high ambient area, i.e., boiler room. Install a liquid line-charging valve to facilitate refrigerant charging. See Figure 3 on page 22 for sizing information. See Figure 5 on page 23 for charge determination.

Discharge Line Sizing. For horizontal runs, the discharge line should be pitched downward, in the direction of flow, at a rate of 1/2" for every 10 feet. This will allow oil to flow towards the condenser. Discharge line sizing is based on the velocity required for sufficient oil return back to the compressor. See Figure 4 on page 22 for discharge line sizing.

Figure 2: Equivalent Length in Feet for Valves and Fittings

Line Size Inches OD	Globe Valve Equivalent Ft	Angle Valve Equivalent Ft	Short Radius Elbow Equivalent Ft	Long Radius Elbow Equivalent Ft
1/2"	43	15	1.4	0.9
5/8"	55	18	1.6	1.0
7/8"	69	24	2.0	1.4
1 1/8"	87	29	2.7	1.9
1 3/8"	102	33	3.2	2.2
1 5/8"	115	34	3.8	2.6
2 1/8"	141	39	5.2	3.4
2 5/8"	159	44	6.5	4.2

Figure 3: Liquid Line Sizing

30 – 65°F Leaving Water Temperature									
Liquid Line Size (O.D.)									
Equiv. FT	5 hp	7.5 hp	10 hp	15 hp	20 hp	25 hp	30 hp	35 hp	40 hp
25	5/8	5/8	5/8	7/8	7/8	7/8	7/8	1 1/8	1 1/8
50	5/8	5/8	5/8	7/8	7/8	7/8	7/8	1 1/8	1 1/8
75	5/8	5/8	5/8	7/8	7/8	7/8	7/8	1 1/8	1 1/8
100	5/8	5/8	5/8	7/8	7/8	7/8	7/8	1 1/8	1 1/8
125	5/8	5/8	7/8	7/8	7/8	7/8	7/8	1 1/8	1 1/8
150	5/8	5/8	7/8	7/8	7/8	7/8	1 1/8	1 1/8	1 1/8
175	5/8	5/8	7/8	7/8	7/8	7/8	1 1/8	1 1/8	1 1/8
200	5/8	5/8	7/8	7/8	7/8	7/8	1 1/8	1 1/8	1 1/8
225	5/8	5/8	7/8	7/8	1 1/8	1 1/8	1 1/8	1 1/8	1 3/8
250	5/8	5/8	7/8	7/8	1 1/8	1 1/8	1 1/8	1 1/8	1 3/8
275	5/8	5/8	7/8	7/8	1 1/8	1 1/8	1 1/8	1 1/8	1 3/8
300	5/8	5/8	7/8	7/8	1 1/8	1 1/8	1 1/8	1 3/8	1 3/8

Figure 4: Discharge Line Sizing

30 – 65°F Leaving Water Temperature									
Discharge Line Size (O.D.)									
Equiv. FT	5 hp	7.5 hp	10 hp	15 hp	20 hp	25 hp	30 hp	35 hp	40 hp
25	7/8	1 1/8	1 1/8	1 3/8	1 3/8	1 5/8	1 5/8	1 5/8	2 1/8
50	7/8	1 1/8	1 1/8	1 3/8	1 3/8	1 5/8	1 5/8	1 5/8	2 1/8
75	7/8	1 1/8	1 1/8	1 3/8	1 3/8	1 5/8	1 5/8	1 5/8	2 1/8
100	7/8	1 1/8	1 1/8	1 3/8	1 3/8	1 5/8	1 5/8	1 5/8	2 1/8
125	7/8	1 1/8	1 1/8	1 3/8	1 3/8	1 5/8	1 5/8	2 1/8	2 1/8
150	7/8	1 1/8	1 1/8	1 3/8	1 5/8	1 5/8	2 1/8	2 1/8	2 1/8
175	1 1/8	1 1/8	1 1/8	1 3/8	1 5/8	1 5/8	2 1/8	2 1/8	2 1/8
200	1 1/8	1 1/8	1 3/8	1 3/8	1 5/8	1 5/8	2 1/8	2 1/8	2 1/8
225	1 1/8	1 1/8	1 3/8	1 5/8	1 5/8	2 1/8	2 1/8	2 1/8	2 1/8
250	1 1/8	1 1/8	1 3/8	1 5/8	1 5/8	2 1/8	2 1/8	2 1/8	2 1/8
275	1 1/8	1 1/8	1 3/8	1 5/8	1 5/8	2 1/8	2 1/8	2 1/8	2 1/8
300	1 1/8	1 1/8	1 3/8	1 5/8	1 5/8	2 1/8	2 1/8	2 1/8	2 1/8

Refrigerant Charge Determination. The approximate amount of refrigerant charge required by the system varies based on the total length of the refrigerant lines and the size of the chiller. Referring to Figure 5, determine the amount of charge based on the horsepower of the chiller and the amount of charge based on discharge and liquid line sizes and lengths. Add these three numbers together to find the final operating charge. The final operating charge must be verified by running the system and checking the liquid line sight glass.

Figure 5: Refrigerant Charge Determination

Chiller Condenser Charge

Horsepower	Lbs. of R-22
5	5.9
7.5	6.1
10	10.8
15	12.6
20	21.2
25	24.2
30	40.2
35	41.2
40	50.2

Field Installed Piping Charge

Pipe O.D. Inches	Discharge Line Ⓢ R-22(Lbs.)	Liquid Line Ⓢ R-22(Lbs.)
1/2"	-	7.2
5/8"	-	11.5
7/8"	1.6	24.0
1 1/8"	2.7	40.9
1 3/8"	4.0	62.2
1 5/8"	5.7	88.1
2 1/8"	10.0	153.0
2 5/8"	15.0	236.0

Ⓢ Based on 100 feet of pipe, 100 °F Liquid, 100 °F Discharge

Oil Charge Determination. The remote air-cooled portable chillers are factory charged with the amount of oil required without field-installed piping. Additional oil required is dependent on the amount of additional refrigerant added.

Calculate the amount of additional oil required by using the following formula:

$$\text{Pints of oil (Sunisco 3GS)} = \text{lbs. of R-22 added for field installed piping} / 100.$$

3-8 Checking Motor Direction

All of our portable chillers have their motor rotations properly phased at the factory. If compressors, pumps, or fans are running in reverse rotation, disconnect and lock out the power source and reverse any two power leads into the chiller disconnect switch.

Caution! *Do not switch leads at the motors, motor starters, or contactors.*

Three-Phase Compressors

Scroll compressors are directionally-dependent and compress in one rotational direction. Reversing rotation direction results in an elevated sound level and a substantially-reduced current draw.

Water Pumps

Correct pump rotation is indicated by a positive pressure of 20 to 40 psi on the pump pressure gauge. Pump rotation should be clockwise when viewed from the motor end. For chillers with optional pumps, check the appropriate pump curve in the Appendix.

Caution! *Do not run pump dry. Doing so will result in seal damage.*

Condenser Fan

Air should be drawn through the condenser and discharged vertically from the chiller.

3-9 Water Reservoir

All portable chillers shipped during the fall, winter, or spring, or those units that are shipped from stock are flushed at the factory with a water/ethylene glycol solution to prevent piping components prone to retaining water from freezing. During startup and when additional solution is required, refer to the ethylene glycol and propylene glycol curves in Figure 6 on page 26. Add a pre-mixed solution of industrial quality (not automotive) ethylene glycol or propylene glycol and water to provide freeze protection to a temperature 20°F (11°C) below the normal chiller operating temperature set point.

Glycol and/or water, with an inhibitor, should be used to protect the materials (copper, steel, stainless steel, and bronze) in the system from corrosion. If you intend to use straight water, we strongly advise a minimum leaving water temperature of 50°F (10°C) or contact the service department.

The following glycol products are available:

Part Number	Description
A0541358	Ethylene glycol, 5 gallons (18.9 liters)
A0539637	Ethylene glycol, 55 gallons (208.2 liters)
A0542990	Propylene glycol, 5 gallons (18.9 liters)
A0542991	Propylene glycol, 55 gallons (208.2 liters)

Caution! *Do not connect make-up water directly to the chilled water reservoir unless you have an approved automatic water make-up system installed.*

The reservoir is not designed to withstand water pressure. The fill opening and vent line must be vented to the atmosphere for proper operation. The optional automatic make-up system is described in section 3-10 on page 27.

Caution! *Do not pressurize tank. Fill and vent lines must be open to atmosphere. Supply and return connections must be trapped and vented to allow vertical risers to drain into tank. Do not overfill system. Allow enough free space in tank for vertical piping to drain.*

If your application has chilled water or process piping above the reservoir fill and vent level, trap and vent the supply and return lines to allow vertical piping to drain into tank. (See page 64.)

Note: *In applications where the process or process piping is above the reservoir, take steps to prevent over pressurization of the reservoir. This condition can occur on system shutdown when the water in the system drains into the reservoir. To prevent this, a vacuum breaker should be installed at the high point of the “To Process” and “From Process” lines. See page 64.*

Figure 6: Ethylene Glycol and Propylene Glycol Curves

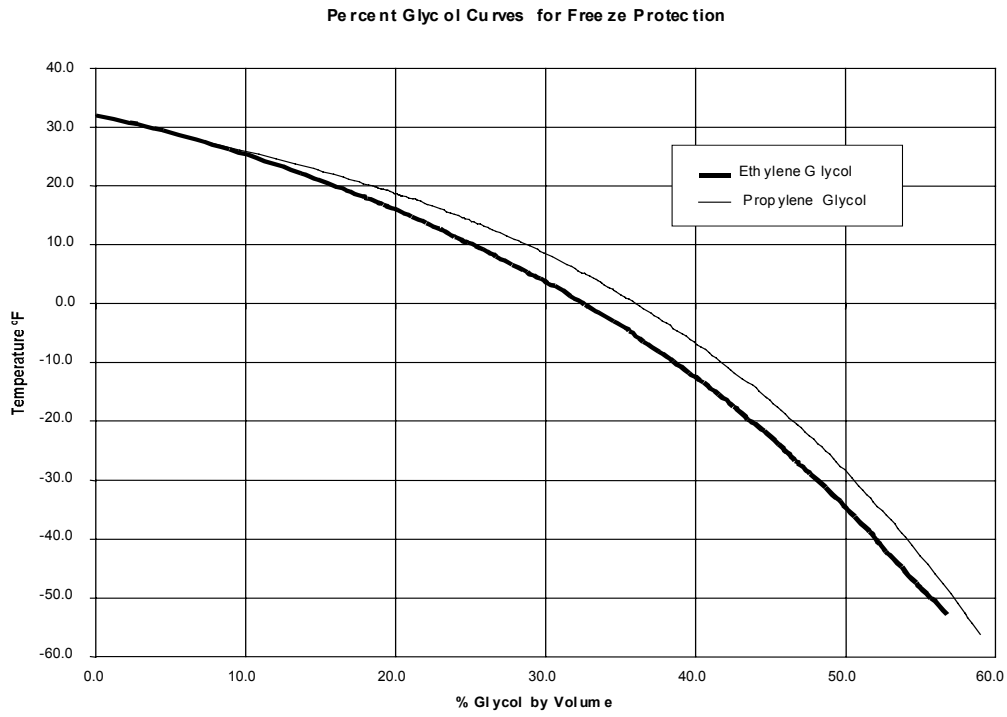

Example: 45°F set point minus 20°F = 25°F.

From Figure 28, 25°F equates to 10% by volume of glycol required.

3-10 Automatic Water Make-Up Option

The chiller may be connected to an automatic make-up system if the optional package (float switch, pressure regulating, pipe fittings, solenoid valve and 1/2" NPT city water make-up connection) is factory installed.

Refer to the typical piping schematics on pages 64-69 in the Appendix for additional components necessary for this installation.

Prevent reservoir over-pressurization by setting the required pressure-regulating valve to limit make-up water pressure to less than 5 psi. The reservoir must remain vented to the atmosphere.

If the automatic make-up system is connected to a city water system, make provisions to prevent backflow contamination. Install an approved backflow preventer in accordance with local codes.

Caution! *Adding straight city water into a glycol/water mixture dilutes the solution and eventually leads to system freeze-up. Damage from freeze-up is not covered by the warranty.*

To prevent system freeze-up in automatic make-up applications, we recommend using either a chemical feeder or make-up reservoir to replenish glycol. Contact the sales department for more information about these configurations.

3-11 Initial Start-Up

- Check the shipping papers against the serial tag to be sure chiller size, type and voltage is correct for the process that will be controlled. Portable chillers are built with a voltage specific compressor and cannot be re-wired for an alternate voltage.
- Check the transformer primary voltage connections to be sure they are configured for the electrical power you are using. The voltage at the main power connection must read within plus or minus ten percent ($\pm 10\%$) of the voltage listed on the serial tag. Electrical connections must conform to all applicable codes.
- Complete chilled water To Process and From Process connections.
- Make sure the chilled water To and From process valves on the chiller are open.
- Be sure the reservoir tank and chilled water circuit piping are filled to the full mark with a water/glycol mixture. The water/glycol mixture should provide for freeze protection to at least 20°F (11°C) below the leaving water temperature you want.
- The air-cooled condenser should have an adequate supply of 60° to 95°F (16° to 35°C) air for proper operation.
- The tower or city water condenser cooling in and out connections should be completed and an adequate supply of 85°F (30°C) tower or 70°F (21°C) city water, at 25 psi pressure, for proper operation.
- Connect the main 3 phase incoming power to the unit making certain that line one (1) L1 is connected to the A phase, line two (2) L2 is connected to the B phase, and line three (3) L3 is connected to the C phase. Check for proper rotation direction of fan(s) and pump(s). 2 hp and 3 hp models are single phase.

The crankcase heater is automatically energized when the main power is applied. It should be on for at least 24 hours before startup to force dissolved refrigerant from the compressor oil.

Chapter 4: Operation





4-1 Panel Buttons, Indicator Lights, and Switches

Microprocessor Controllers

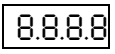
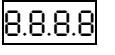
Standard chillers use a microprocessor-based PID controller. These controllers are modular, self-contained units that can slide from their mounting housing. They are factory set and adjusted; no field adjustment to the internal controls are necessary. Their standard operation range is 30°F to 65°F (-1°C to 18°C). See Figure 7: Typical Portable Chiller Microprocessor Controller.

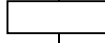
E5CK Controller

Indicator	Name	Description
PV 	Process Value LED	During normal operation, the large red PV LED on the controller displays the actual process temperature at the “To Process” thermocouple. It also lists parameter symbols during setup and error messages if an error occurs
SV 	Set Value LED	During normal operation, the green SV LED on the controller displays the process set point you want the chiller to maintain. It also displays parameter and pre-set function values during set up.
<input type="checkbox"/> OUT1	Out 1 LED	The orange OUT1 LED lights when the control output energizes the hot-gas bypass solenoid valve
<input type="checkbox"/> OUT2	Out 2 LED	The orange OUT2 LED lights whenever the process temperature is two degrees or more above the “To Process” setpoint. The compressor then comes on and runs until the temperature at the “To Process” thermocouple is two degrees below the setpoint.
<input type="checkbox"/> MANU	MANU LED	The orange MANU LED is not used and does not light.
<input type="checkbox"/> STOP	Stop LED	The orange STOP LED is not used and does not light.
<input type="checkbox"/> RMT	RMT LED	The orange RMT LED is lit during remote operation.
<input type="checkbox"/> AT	AT LED	The orange AT LED flashes during auto-tuning.

Indicator	Name	Description
 SUB1	SUB 1 LED	The orange SUB1 LED lights when the process temperature is two degrees or more below the “To Process” setpoint. The compressor then shuts down by means of a latching circuit, and it does not run again until the temperature at the “To Process” thermocouple is two degrees above the setpoint.
 AT	AutoTune Key	Press and hold the AT key for two seconds to initiate or stop the auto-tune function
	Display Key	The functions of the Display key change based on how long you press it. Press the Display key for less than one (1) second to scroll through parameters within the mode.
	Down Arrow Key	Each press of the Down Arrow key decrements or reduces values or settings on the SV display
	Up Arrow Key	Each press of the Up Arrow key increments or advances the values or settings on the SV display.

Sterlco 2000 Controller











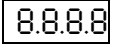
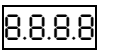
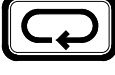

Indicator	Name	Description
T 	Process Value LED	During normal operation, the large red T LED on the controller displays the actual process temperature at the “To Process” thermocouple. It also lists parameter symbols during setup and error messages if an error occurs
SP 	Set Value LED	During normal operation, the green SP LED on the controller displays the process set point you want the chiller to maintain. It also displays parameter and pre-set function values during set up.
	Index Key	Press the Index key for less than (1) second to scroll through parameters within the mode.
	Up Arrow Key	Each press of the Up Arrow key increments or advances the values or settings on the SP display.
	Down Arrow Key	Each press of the Down Arrow key decrements or reduces the values or settings on the SP display.
	Enter Key	Press the Enter key to verify or confirm an entry.

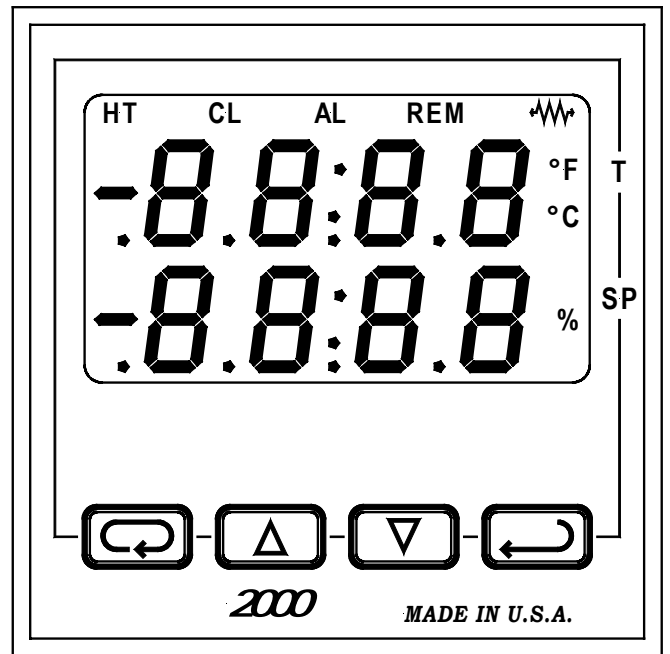
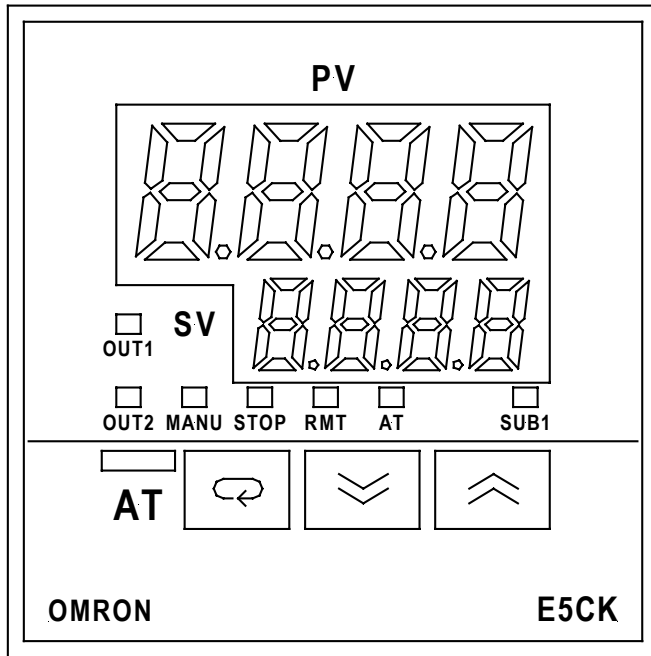
Figure 7: Typical Portable Chiller Microprocessor Controllers



Graphic Panel

(See Figure 8 on Page 32.)

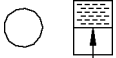
Indicator	Name	Description
	Compressor On Light	The Compressor On light turns on whenever the compressor is operating.
	Low Temperature Light	The Low Temperature light comes on if the process water/glycol temperature drops below the High/Low thermostat set point. The High/Low thermostat stage one switch opens the control circuit shutting down the compressor, but the process water/glycol pump(s) continue to operate. This action prevents possible chiller evaporator freeze-up.
	Hot Gas Bypass Light	The Hot Gas By-Pass light turns on when the hot gas bypass valve is in operation. The OUT1 LED on the controller also lights when the hot gas bypass valve is in operation.
	High Temperature Light	The High Temperature light comes on if the process water/glycol temperature rises above the High/Low thermostat stage two set point. The High/Low thermostat stage two switch opens the control circuit shutting down the process water/glycol pump(s), and the chiller shuts off. This action prevents possible system failure from overheating of the process water/glycol.
	Pump On Light	The Pump On light, installed on chillers with a pump, lights whenever the pump(s) operates.
	High Discharge Temperature Light	The High Discharge Temperature light comes on if the compressor discharge line temperature switch opens. This switch prevents possible compressor failure due to over loading, the compressor stops, but the pump(s) continue to run. This occurs when the discharge line temperature rises above 260°F (127°C). Call a qualified refrigeration service technician or contact the Service Department.
	Pump Overload Light	The Pump Overload light, installed on chillers with a pump(s), lights whenever a pump motor(s) has shut down from a motor overload condition.
	High Refrigerant Pressure Light	The High Refrigerant Pressure light comes on if the compressor discharge pressure exceeds the limit of the high pressure cutout switch. The compressor stops but the pump(s) continue to run until you manually reset the high-pressure cutout switch. Call a qualified refrigeration service technician or contact the Service Department.



Indicator	Name	Description
	Low Water Flow/Pressure Light	The Low Water Flow/Pressure light comes on when the flow switch (pressure switch on 2 & 3 hp models) senses that the water/glycol flow rate through the evaporator has dropped below an acceptable level. The flow switch opens shutting down the pump(s) and the chiller.
	Low Refrigerant Pressure Light	<p>The Low Refrigerant Pressure light come on if the compressor suction pressure drops below the limit of the low pressure cutout switch. The compressor shuts off, but the pump(s) continues to run.</p> <p>The indicator turns off and compressor restarts automatically when the refrigerant pressure rises to the limit of the low-pressure cutout switch. Call a qualified refrigeration service technician or contact the Service Department.</p>
	Low Oil Pressure Light	<p>The Low Oil Pressure light is installed on chillers with a semi-hermetic compressor that have an oil pump. A differential pressure switch monitors the difference between crankcase pressure and oil pump pressure.</p> <p>If the pressure drops to an unsafe level for more than two minutes the switch will open the control wiring circuit, shutting off the compressor, turning the light on, but allowing the pump(s) to continue running. This is a manual reset switch. Call a qualified refrigeration service technician or the Service Department.</p>
	Control Power Lighted Switch	The green, lighted, sustained-on Control Power Switch lights whenever the switch is in the ON position and the control circuit is energized.
	Alarm Silence Switch	The red momentary-on Alarm Silence Switch is used to turn off the audible alarm on chillers that are built with the audible or audible/visual alarm option. This switch is always provided and requires no additional wiring if either alarm option is installed at a later time.

Figure 8: Typical Graphic Panels

(With E5CK Controller)

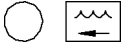
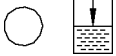
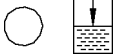
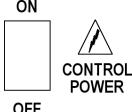

(With Sterlco 2000 Controller)

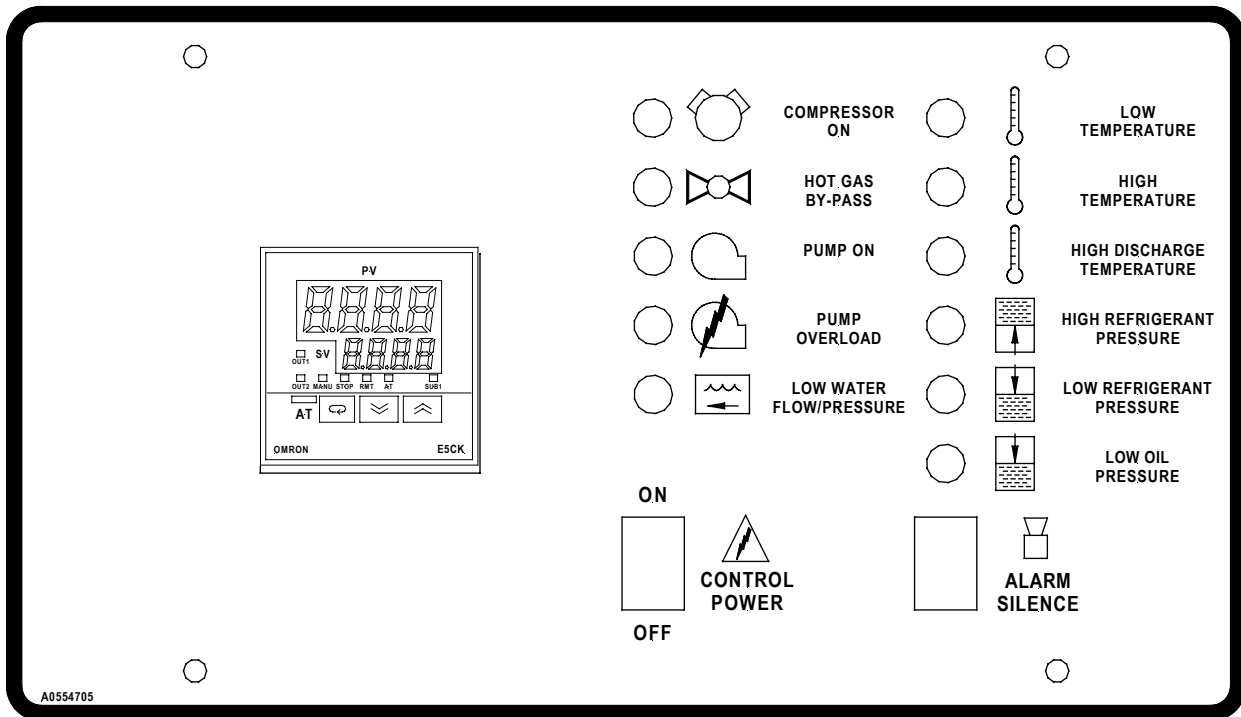
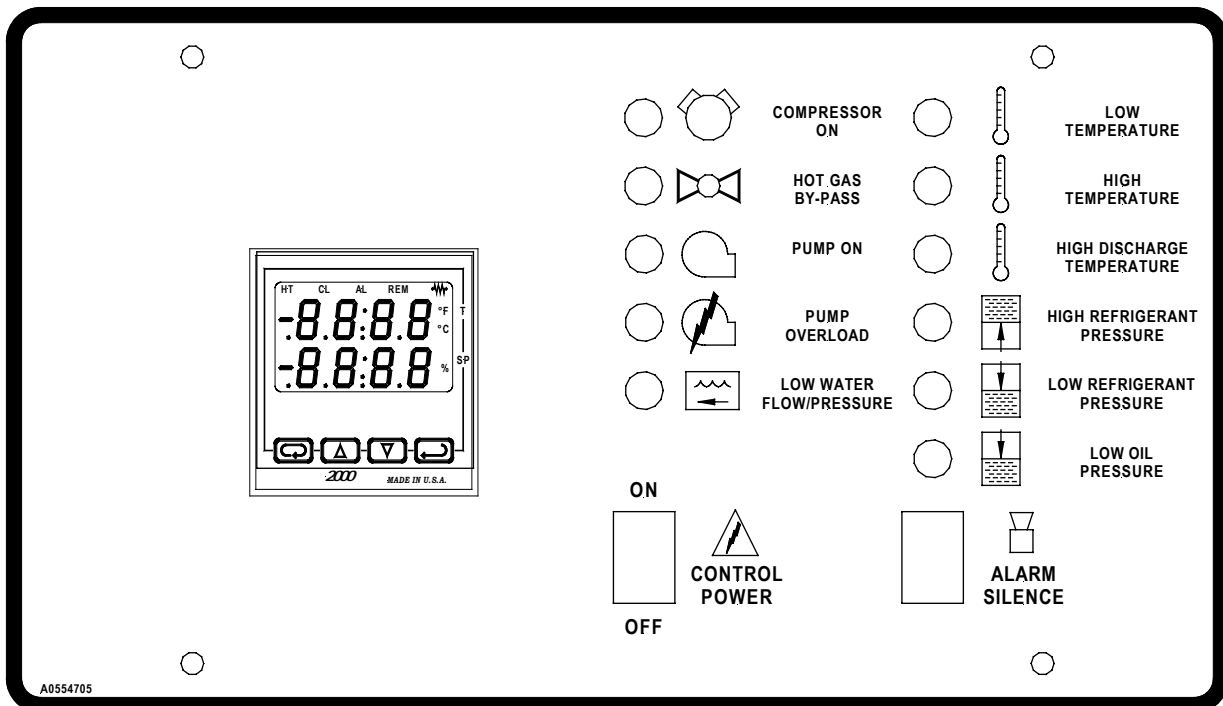

4-2 Start-up

1. Turn on the chiller and put it under a process load.
2. Set the controller for the To Process temperature you want, using the Up Arrow button or the Down Arrow button located on the face of the controller.
3. Adjust the High/Low thermostat, located in the electrical enclosure, to 8°F (4.4°C) below the To Process temperature you want. The High/Low thermostat is factory-set at 42°F (6°C). See page 36 for information on resetting the High/Low thermostat.
4. Check the pump amp draw and pump pressure. Make sure that the amp draw reading is within the running load and service factor amps.
5. Operate the chiller, looking for any leaks and listening for unusual noises or vibrations that could indicate improper operation.

Note: *Elevated sound level and substantially reduced current draw indicate reverse rotation. After several minutes of operation, the compressor internal protector trips.*

4-3 Setting the Process Water Temperatures

E5CK Controller

To change the process water temperature set point, press the Up Arrow button to raise the set point, and press the Down Arrow button to lower the set point.

Sterlco 2000 Controller

To change the process water temperature set point, press the Index key, then press the Up Arrow button to raise the set point or the Down button to lower the set point. Press the Enter key for the controller to accept the new values. Press the Index key to return to the Home position.

4-4 Auto-Tuning

E5CK Controller Only

The Auto-Tune function lets you fine-tune the control PID to process requirements. Activate the Auto-Tune function whenever the process under control changes. Don't be alarmed by control response. It may take the process temperature above and below the set points as many as three times before leveling off and controlling the process set point. Auto-Tuning can take up to 45 minutes and is best done before any product is being run.

1. Press and hold down the AT key for several seconds until the AT indicator flashes.
2. When the AT LED light stops flashing, the controller is tuned and ready for operation.

4-5 Optional Communications

The communications function allows you to monitor and set controller parameters by a program prepared and running on a host computer connected to the controller.



When using the communications function, you must add on the unit for RS-232C or RS-485 communications. The controller communications function allows you to read/write parameters, do operating instructions, and select the setting level.

4-6 Programming the Electronic High/Low Thermostat

The thermostat control is located in the chiller enclosure. The control has three control keys and a one-line, four-character LCD display.

The thermostat control has a lockout slide switch to prevent tampering by unauthorized personnel. The switch is located on the inside cover of the thermostat. The keypad is disabled when the switch is moved to the left in the “Lock” position. The keypad functions normally when the switch is moved to the right in the “Unlock” position. All chillers are shipped with the switch in the “Lock” position.

Thermostat Buttons

Indicator	Name	Description
	Set Button	The Set button is used to enter the programming mode for the thermostat.
	Up Arrow button	Each press of the Down Arrow key decrements or reduces values or settings on the display
	Down Arrow button	Each press of the Up Arrow key increments or advances the values or settings on the display.

Perform the following procedures to program the electronic High/Low Thermostat control:

Select Fahrenheit or Celsius

1. Press the Set key once to access Fahrenheit/Celsius mode
Use the Up Arrow and Down Arrow keys to toggle between Fahrenheit and Celsius.

Stage 1: Freeze Protection

2. Press the Set key again to access the low temperature set point. The screen displays the current set point and the S1 indicator blinks on and off to indicate that the control is in set point mode.
Use the Up Arrow and Down Arrow keys to adjust the set point. At 50°F (10°C) leaving water temperature, the setting should be 42°F (6°C).
3. Press the Set key again to access the Stage 1 differential. The screen displays the current differential and the DIF1 indicator blinks on and off to indicate that the control is in differential mode.
Use the Up Arrow and Down Arrow keys to adjust the differential. The setting should be 12°F.
4. Press the Set key again to access Stage 1 cooling or heating mode. The screen displays the current mode: C1 for cooling or H1 for Heating.
Use the Up Arrow and Down Arrow keys to toggle between C1 or H1. The setting should be C1.

Stage 2: High Temperature Protection

5. Press the Set key again to access the high temperature set point. The screen displays the current set point and the S2 indicator blinks on and off to indicate that the control is in set point mode.
Use the Up Arrow and Down Arrow keys to adjust the set point. The setting should be 100°F (38°C).
6. Press the Set key again to access the Stage 2 differential. The screen displays the current differential and the DIF2 indicator blinks on and off to indicate that the control is in differential mode.
Use the Up Arrow and Down Arrow keys to adjust the differential. The setting should be 2°F.
7. Press the Set key again to access Stage 2 cooling or heating mode. The screen displays the current mode: C1 for cooling or H1 for Heating.
Use the Up Arrow and Down Arrow keys to toggle between C1 and H1. The setting should be C1.

Chapter 5: Maintenance

5-1 Lubrication

Grease all blower bearings, fan and blower motors, and pump motors that do not have permanently sealed bearings. Remove the grease relief plug (motors only) before adding grease, add grease until a small amount pours out, and replace the plug when finished.

Caution! *Failure to remove the grease relief plug will result in dislodging the bearing grease seal, eventually causing bearing failure.*

Refrigeration compressors are hermetically sealed and no lubrication is required.

5-2 Filter Cleaning

Air filter cleaning is important to keep your air-cooled portable chiller operating at peak efficiency and capacity. Clean the filters whenever they appear dirty, or at regularly scheduled intervals.

1. Turn the chiller off.
2. Slide the filter up off of the retaining pins holding it in place along its bottom.
3. Tip the bottom of the filter away from the chiller.
4. Slide it down and out.
5. Wash down the filter with clean water (preferably with a garden hose), directing the flow of water opposite the direction of airflow. If dirt is heavy, use a mild detergent and rinse well. Allow the filter to dry completely before replacing it on the chiller.

Note: *Keep a spare air filter set on hand. Install and use it while cleaning).*

Caution! *Do not use compressed air to blow off a dirty filter. It will not clean very well, and the filter could be damaged. Never run the chiller without properly installed filters.*

5-3 Maintaining the Condenser

Dirty condenser heat exchange surfaces reduce system capacity and efficiency.

Air- and Remote Air-Cooled Chillers

Brush or vacuum light dirt accumulations off the aluminum condenser fins. Avoid bending or damaging them. Heavy dirt accumulations on the fins may require professional cleaning.

Water-Cooled Chillers

Proper water treatment will greatly reduce cleaning intervals.

Coaxial Condensers (2 to 7.5 hp chillers). Remove dirt and slime in the condenser tube water side by reverse-circulating with a mild detergent and water solution. Remove mineral deposits by reverse circulating Liquid Inhibited Acid De-Scaling Solution (Part No. A0502600) through the water side of the condenser. Follow the directions on the container.

Shell & Tube Condensers (10 to 40 hp chillers). Remove dirt and slime in the condenser tube water side by cleaning with a nylon tube brush. Remove mineral deposits by reverse circulating Liquid Inhibited Acid De-Scaling Solution (Part No. A0502600) through the tube water side of the condenser. Follow the directions on the container.

The refrigerant side is sealed and requires no routine maintenance.

Caution! *Do not use steam or water over 140°F (60°C) to clean a condenser unless you are monitoring the refrigeration circuit for excessive pressure with gauges. Only a trained technician should use this method.*

5-4 Maintaining the Evaporator

Dirty evaporator heat exchange surfaces reduce system capacity and efficiency. Remove dirt and slime in the evaporator by reverse-circulating with a mild detergent and water solution.

Remove mineral deposits by reverse-circulating Liquid Citric Acid De-Scaling Solution (Part No. A0536607). Follow the directions on the container.

5-5 Evaporator Process Piping Y-Strainer

The process piping Y-strainer requires periodic cleaning of its screen to insure the proper flow through the evaporator. To clean the strainer screen, remove the access plug and retaining cap, and pull out the screen.

Wipe, brush, or vacuum out any dirt left in the strainer body. Clean the screen and replace it in the strainer taking care to fit it squarely into the machined seat provided.

Caution! *Do not forget to re-install the screen after cleaning it. Operating the chiller with no strainer screen can potentially plug the evaporator with dirt. The warranty does not cover chiller failures from a dirty evaporator.*

5-6 Preventative Maintenance Service

Follow a systematic preventive maintenance program to help avoid costly down time. Call the Service Department to arrange a schedule of inspections. This service can be tailored to fit your maintenance requirements. These inspections include, but are not limited to:

- Checking refrigerant suction and discharge pressures
- Checking safety and operating conditions
- Checking voltage and amperage of all motors
- Checking all electrical connections
- Checking quantity of refrigerant
- Checking compressor oil level
- Checking lubrication of motor and pump bearings.
- Checking circulating pump operation
- Checking flow through heat exchangers
- Checking compressor efficiency
- Checking noise levels

Chapter 6: Troubleshooting

Problem	Possible cause	Solution
Unit does not run.	No power.	Check main disconnect, fuses, wiring, and power lead to unit.
	Wrong voltage supplied to unit.	Voltage must be within plus or minus 10% of nameplate rating.
	Defective on/off switch.	Replace.
	Control circuit fuse blown.	Replace control circuit fuse.
		Check transformer.
		Check for a short circuit.
	Defective control transformer.	Replace.
Piping flow switch circuit open.	Add water or water/glycol solution as required.	
Pump motor off on overload.	Reset and test.	
Pump runs; compressor does not.	High/Low thermostat set higher than temperature of liquid in system.	Lower thermostat stage 1 set to 10°F (6°C) below the leaving temperature you want.
	Defective High/Low thermostat.	Replace.
	Low refrigerant indicator on.	Check refrigerant charge.
	Refrigerant low pressure switch contacts open.	Sight glass should be clear and the moisture indicator should be green while compressor is running. Bubbles or foaming is normal when the hot-gas bypass solenoid is energized. Call for service if bubbling is occurring and/or moisture indicator is yellow.
		Refrigerant high-pressure indicator on.
	Fan motor out on overload.	Reset and test.
	Defective fan cycling control.	Replace.
	Defective fan motor.	Repair or replace.
	Compressor internal overload or fuses are open.	Allow time to cool and reset, then check for high/low volt-age. It must be within plus or minus 10% of the nameplate rating.
		Check for open fuses and loose compressor electrical connections.
	Compressor contactor holding coil open.	Repair or replace.
	Defective pump motor to compressor auxiliary contact.	Repair or replace.
	Broken wire in the compressor control circuit.	Locate and repair.
Pump runs, compressor cycles at short intervals.	Incorrect High/Low Thermostat setting.	Lower set point to 10°F (6°C) below desired leaving water temperature.

Problem	Possible cause	Solution
Water temperature is too high.	Water/glycol mixture inadequate for process.	Make sure that the water/glycol mixture protection is right for the process.
	Defective or improperly set High/Low thermostat.	Adjust or replace.
	Refrigerant low pressure switch is set too high.	Call service to adjust pressure control.
	Refrigerant charge is low.	Call service to find and repair the leak, then have refrigerant added.
Pump pressure low (refer to curves for normal pressure for various pumps).	Pump running in reverse.	Verify rotation; if running in reverse rotation, reverse any two main power leads. Re-verify for correct pump rotation.
	Check for foreign matter.	Clean the system.
Pump pressure is too high.	Restricted water flow.	Check for partially closed valves etc. Make sure that all lines are properly sized.
Unit runs continuously, but not enough cooling power.	Restricted condenser air.	Clean filters.
		Clean condenser.
	Unit low on refrigerant.	Check the refrigerant charge.
	Compressor not operating efficiently.	Call service.
	Unit under-sized for application.	Call sales rep.

Chapter 7: Appendix

7-1 Warranty

We warrant all of our equipment to be free from defects in workmanship and material when used under recommended conditions. The manufacturer's obligation is limited to repair or replace FOB the factory any parts that are returned prepaid within one year of equipment shipment to the original purchaser, and which, in the manufacturer's opinion, are defective. Any replacement part assumes the unused portion of this warranty.

This parts warranty does not cover any labor charges for replacement of parts, adjustment repairs, or any other work. This warranty does not apply to any equipment which, in the manufacturer's opinion, has been subjected to misuse, negligence, or operation in excess of recommended limits, including freezing or which has been repaired or altered without the manufacturer's express authorization. If the serial number has been defaced or removed from the component, the warranty on that component is void. Defective parts become the property of the warrantor and are to be returned.

The manufacturer is not liable for any incidental, consequential, or special damages or expenses. The manufacturer's obligation for parts not furnished as components of its manufactured equipment is limited to the warranty of the manufacturers of said parts.

Any sales, use, excise, or other tax incident to the replacement of parts under this warranty is the responsibility of the purchaser.

The manufacturer neither assumes nor authorizes any other persons to assume for it any liability in connection with the sale of its equipment not expressed in this warranty.

Many types of the manufacturer's equipment carry an additional one-year service policy. Consult your sales representative for specific details.

7-2 Technical Assistance

Parts Department

Call toll-free 7am–5pm CST [800] 423-3183 or call [414] 354-0970, Fax [414] 354-6421
The ACS Customer Service Group will provide your company with genuine OEM quality parts manufactured to engineering design specifications, which will maximize your equipment's performance and efficiency. To assist in expediting your phone or fax order, please have the model and serial number of your unit when you contact us. A customer replacement parts list is included in this manual for your convenience. ACS welcomes inquiries on all your parts needs and is dedicated to providing excellent customer service.

Service Department

Call toll-free 8am–5pm CST [800] 657-4679 or call [414] 354-0970
Emergencies after 5pm CST, call [847] 439-5655
We have a qualified service department ready to help. Service contracts are available for most of our products.

Sales Department

Call [414] 354-0970 Monday–Friday, 8am–5pm CST
Our products are sold by a world-wide network of independent sales representatives. Contact our Sales Department for the name of the sales representative nearest you.

Contract Department

Call [414] 354-0970 Monday–Friday, 8am–5pm CST
Let us install your system. The Contract Department offers any or all of these services: project planning; system packages including drawings; equipment, labor, and construction materials; and union or non-union installations.

7-3 Drawings and Specifications

2 hp and 3 1/2 hp Air-Cooled Portable Chillers

Nominal operating parameters for air-cooled models are 50°F (10°C) leaving water temperature at 2.4 gpm per ton (9.1 lpm per 3.517 kW) with 95°F (35°C) ambient air. For 50 Hz applications, multiply capacity by 0.83. Nominal 60 Hz capacity flow rate must be maintained.

HP	Nominal cooling capacity ① in tons		Water flow gpm ②	Compressor hp	Nominal pump hp	Discharge air		Power in amps ③, 460/3/60 ④	
	no pump	1 pump				openings	cfm ⑤	rated	running
2	1.9	1.7	4.6	2.0	1.0	1 @ 18.5"	1,475	8.0	6.9
3.5	3.3	3.1	7.9	3.5	1.0	1 @ 18.5"	2,350	10.9	8.8

- ① Based on 50°F (10°C) chilled water supply temperature and 95°F (35°C) ambient air. Optional additional process pump hp (kW) reduces chiller capacity by 0.2 tons per hp (0.703 kW ref. cap. per 0.746 kW pump power).
- ② Based on 2.4 gpm per ton (9.1 lpm per 3.517 kW), nominal 1 pump.
- ③ An optional oversized process pump adds to the total rated or running chiller amperage. To find the new total chiller amperage, subtract the standard process pump amperage from the optional pump amperage (see Figure 1 on page 16), and add it to the chiller rated or running amperage.
- ④ Multiply 460/3/60 amperage by 2.0 for 208-230/3/60 amperages.
- ⑤ To convert cfm to cmh, multiply by 1.699.

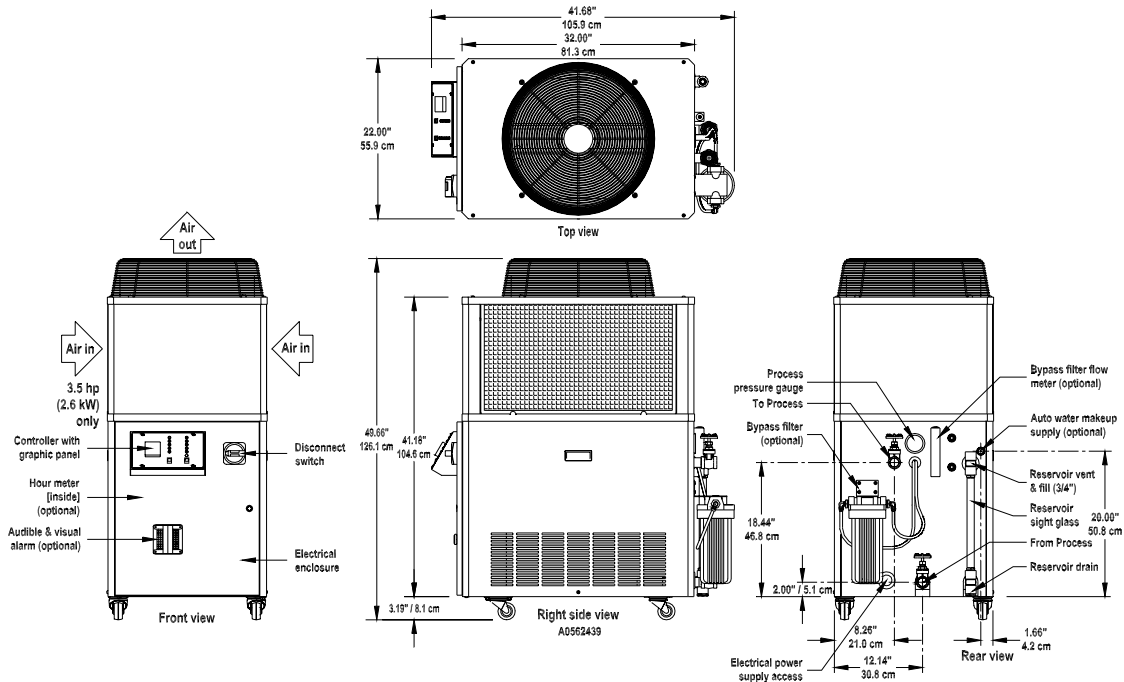

2 and 3 1/2 hp portable chillers come standard with 2 1/2" (63 mm) swivel casters.

Compressor hp	Process connections in. NPT	Dimensions inches ①			Weights		
		height	width	depth	Dry ② lbs.	Ship. ② lbs.	Oper. ② ③ lbs.
2.0	3/4" or 1.0"	49.7"	22.0"	41.7"	387	417	437
3.5	1.0"	49.7"	22.0"	41.7"	410	440	460

- ① To convert to *cm*, multiply by **2.54**. Add to height dimension based on mounting options.
- ② Weight is for standard chiller. Some optional features will increase weight. Multiply lbs. by **0.454** to calculate *Kg*.
- ③ Operating weight is with a full 6-gallon (22.7 liter) reservoir tank of water.

5 hp and 7.5 hp Air-Cooled Portable Chillers

Nominal operating parameters for air-cooled models are 50°F (10°C) leaving water temperature at 2.4 gpm per ton (9.1 lpm per 3.517 kW) with 95°F (35°C) ambient air. **For 50 Hz applications**, multiply capacity by **0.83**. *Nominal 60 Hz capacity flow rate must be maintained.*

HP	Nominal cooling capacity ① in tons			Water flow gpm ②	Com-pressor hp	Nom. pump hp	Discharge air ③		Power in amps ④, 460/3/60 ⑤			
	no pump	1 pump	2 pump				openings	cfm ⑥	1 pump		2 pumps	
									rated	running	rated	running
5	4.8	4.6	4.5	11.6	5.0	1.0	1 @ 27"	3,400	14.0	11.0	14.9	11.9
7.5	6.6	6.4	6.3	15.7	7.5	1.0	1 @ 27"	5,100	18.2	14.6	19.1	15.5

- ① Based on 50°F (10°C) chilled water supply temperature and 95°F (35°C) ambient air. Optional additional process pump hp reduces chiller capacity by 0.2 tons per hp (0.703 kW ref. cap. per 0.746 kW pump power).
- ② Based on 2.4 gpm per ton (9.1 lpm per 3.517 kW), nominal 1 pump.
- ③ Customer use of ductwork requires optional high-pressure fan for 5 hp to 15 hp (3.73 kW to 11.20 kW) models.
- ④ An optional oversized process pump adds to the total rated or running chiller amperage. To find the new total chiller amperage, subtract the standard process pump amperage from the optional pump amperage (see Figure 1 on page 16), and add it to the chiller rated or running amperage.
- ⑤ Multiply 460/3/60 amperage by 2.0 for 208-230/3/60 amperages; multiply by 0.8 for 575/3/60 amperages.
- ⑥ To convert cfm to cmh, multiply by 1.699.

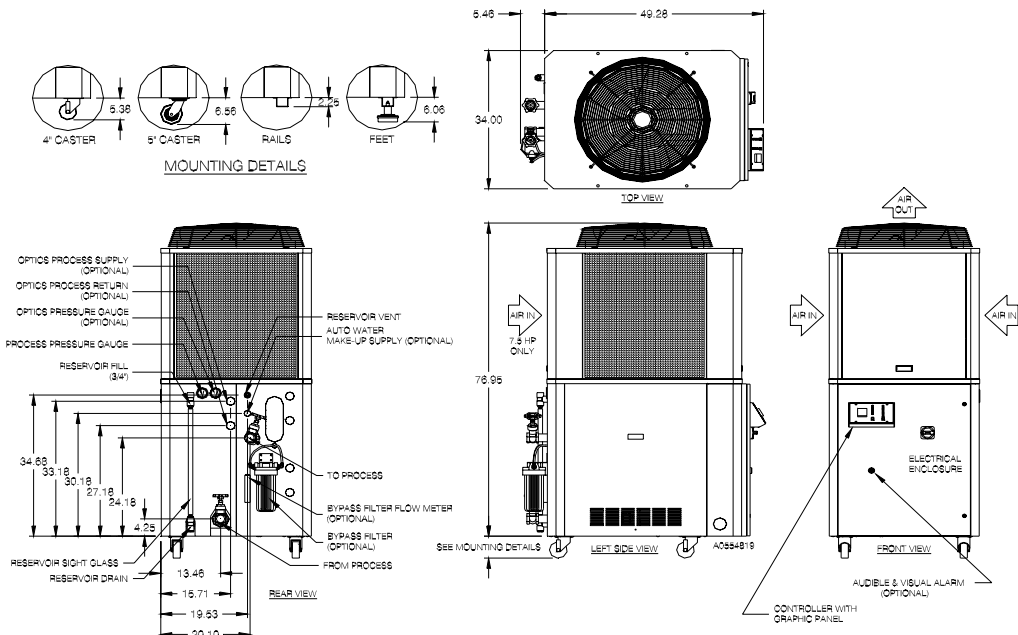

5 hp and 7.5 hp air-cooled chillers come standard with 4" (101 mm) swivel casters.

Com-pressor hp	Process connections, in. NPT				Dimensions in inches ①			Weights		
	1 pump	2 Pumps	no pump, no tank	1 pump, no tank, to/from	height	width	depth	Dry ② lbs.	Ship. ② lbs.	Oper. ② ③ lbs.
5.0	1.5/2.0	2.0	1.5"	1.5" / 2.0"	82.3"	34.0"	54.7"	872	1,047	1,205
7.5	1.5/2.0	2.0	1.5"	1.5" / 2.0"	82.3"	34.0"	54.7"	922	1,097	1,255

- ① To convert to *cm*, multiply by **2.54**. Add to height dimension based on mounting options.
- ② Weight is for standard chiller. Some optional features will increase weight. Multiply lbs. by **0.454** to calculate *Kg*.
- ③ Operating weight is with a full 20-gallon (76 liter) reservoir tank of water.

10 hp and 15 hp Air-Cooled Portable Chillers

Nominal operating parameters for air-cooled models are 50°F (10°C) leaving water temperature at 2.4 gpm per ton (9.1 lpm per 3.517 kW) with 95°F (35°C) ambient air. **For 50 Hz applications, multiply capacity by 0.83. Nominal 60 Hz capacity flow rate must be maintained.**

HP	Nominal cooling capacity ① tons			Water flow gpm ②	Com-pressor hp	Nom. pump hp	Discharge air ③		Power in amps ④, 460/3/60 ⑤			
	no pump	1 pump	2 pump				openings	cfm ⑥	1 pump		2 pumps	
									rated	running	rated	running
10	9.9	9.5	9.4	23.8	10.0	2.0	2 @ 27"	5,800	26.1	21.8	27.8	23.5
15	14.5	14.1	14.0	34.9	15.0	2.0	2 @ 27"	10,000	33.3	27.5	35.0	29.2

- ① Based on 50°F (10°C) chilled water supply temperature and 95°F (35°C) ambient air. Optional additional process pump hp reduces chiller capacity by 0.2 tons per hp (0.703 kW ref. cap. per 0.746 kW pump power).
- ② Based on 2.4 gpm per ton (9.1 lpm per 3.517 kW), nominal 1 pump.
- ③ Customer use of ductwork requires optional high-pressure fan for 5 hp to 15 hp (3.73 kW to 11.20 kW) models.
- ④ An optional oversized process pump adds to the total rated or running chiller amperage. To find the new total chiller amperage, subtract the standard process pump amperage from the optional pump amperage (see Figure 1 on page 16), and add it to the chiller rated or running amperage.
- ⑤ Multiply 460/3/60 amperage by 2.0 for 208-230/3/60 amperages; multiply by 0.8 for 575/3/60 amperages.
- ⑥ To convert cfm to cmh, multiply by 1.699.

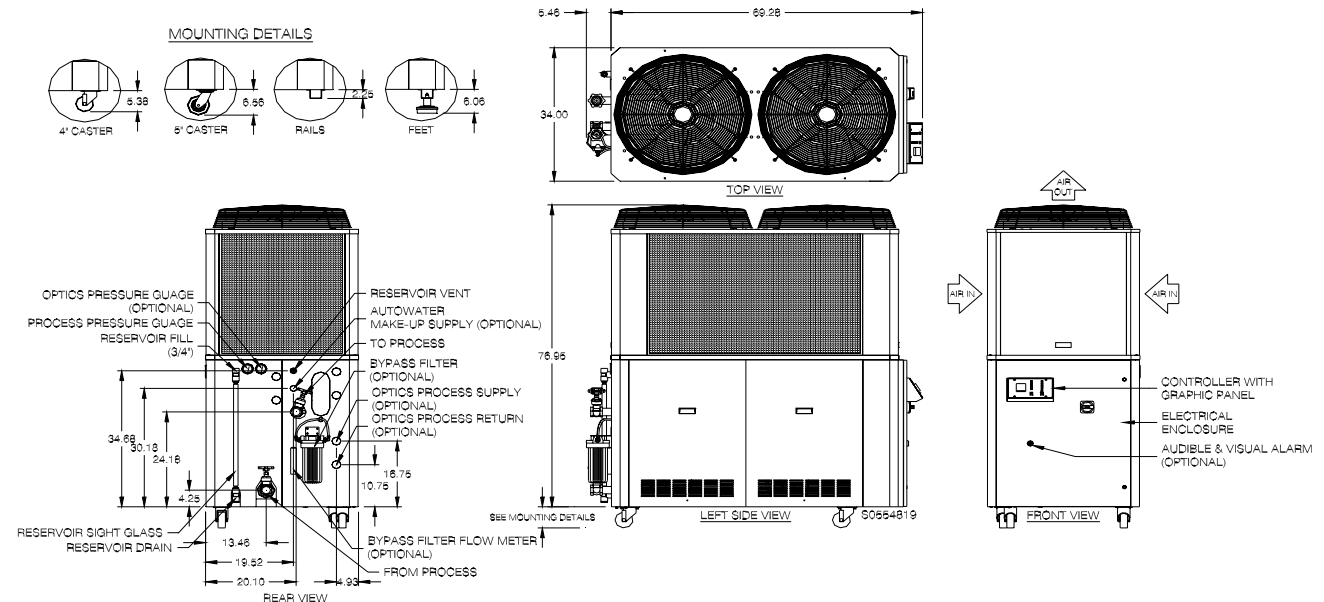

10 hp and 15 hp air-cooled chillers come standard with 4" (101 mm) swivel casters.

Com-pressor hp	Process connections, in. NPT				Dimensions in inches ①			Weights		
	1 Pump	2 pumps	no pump, no tank	1 pump, no tank, to/from	height	width	depth	Dry ② lbs.	Ship. ② lbs.	Oper. ② ③ lbs.
10.0	1.5"/3.0"	2.0"/3.0"	1.5"	1.5" / 2.0"	82.3"	34.0"	74.7"	1,305	1,570	1,637
15.0	2.0"/3.0"	2.5"/3.0"	2.0"	2.0" / 3.0"	82.3"	34.0"	74.7"	1,388	1,653	1,720

- ① To convert to *cm*, multiply by **2.54**. Add to height dimension based on mounting options.
- ② Weight is for standard chiller. Some optional features will increase weight. Multiply lbs. by **0.454** to calculate *Kg*.
- ③ Operating weight is with a full 40-gallon (151 liter) reservoir tank of water.

20 hp, 25 hp, and 30 hp Air-Cooled Portable Chillers

Nominal operating parameters for air-cooled models are 50°F (10°C) leaving water temperature at 2.4 gpm per ton (9.1 lpm per 3.517 kW) with 95°F (35°C) ambient air. **For 50 Hz applications**, multiply capacity by **0.83**. *Nominal 60 Hz capacity flow rate must be maintained.*

HP	Nominal cooling capacity ① tons			Water flow gpm ②	Com-pressor hp	Nom. pump hp	Discharge air		Power in amps ③, 460/3/60 ④			
	no pump	1 pump	2 pump				openings	cfm ⑤	1 pump		2 pumps	
									rated	running	rated	running
20	19.4	18.4	18.0	46.5	2 @ 10	5	25" x 18.5"	10,200	48.3	42.0	51.4	45.1
25	23.9	22.8	22.4	57.2	2 @ 13	5	25" x 18.5"	13,300	62.1	48.3	65.2	51.4
30	29.2	28.2	27.8	70.2	2 @ 15	5	25" x 18.5"	18,150	74.1	64.4	77.2	67.5

- ① Based on 50°F (10°C) chilled water supply temperature and 95°F (35°C) ambient air. Optional additional process pump hp reduces chiller capacity by 0.2 tons per hp (0.703 kW ref. cap. per 0.746 kW pump power).
- ② Based on 2.4 gpm per ton (9.1 lpm per 3.517 kW), nominal 1 pump.
- ③ An optional oversized process pump adds to the total rated or running chiller amperage. To find the new total chiller amperage, subtract the standard process pump amperage from the optional pump amperage (see Figure 1 on page 16), and add it to the chiller rated or running amperage.
- ④ Multiply 460/3/60 amperage by 2.0 for 208-230/3/60 amperages; multiply by 0.8 for 575/3/60 amperages.
- ⑤ To convert cfm to cmh, multiply by 1.699.

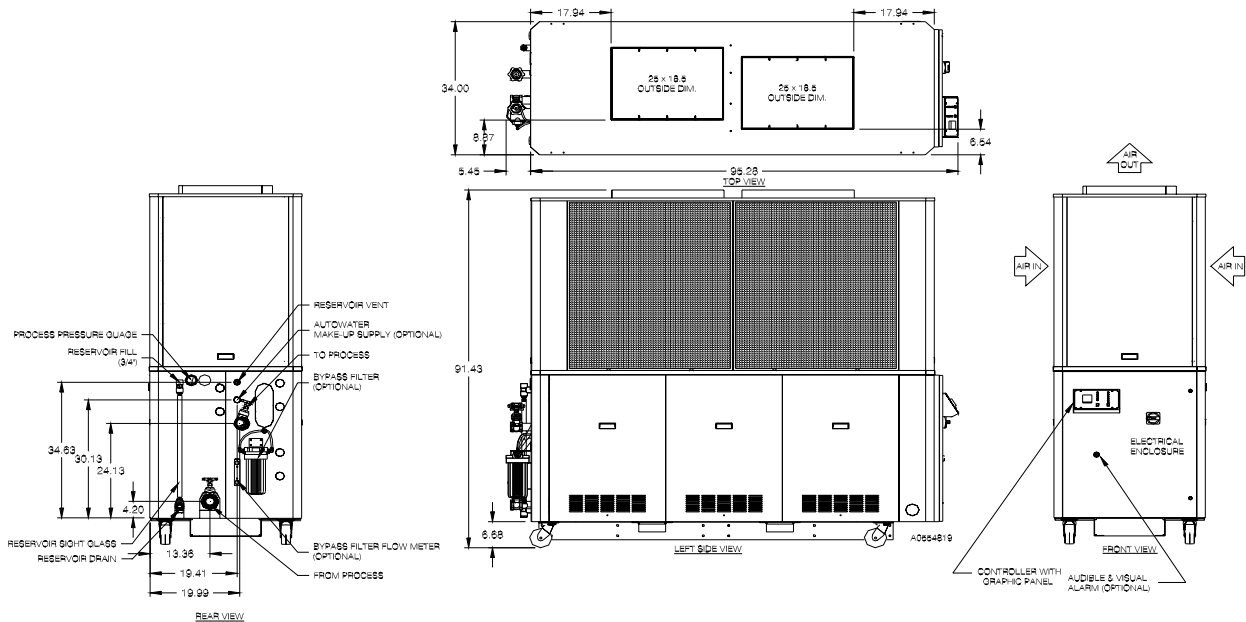

20 hp, 25 hp, and 30 hp air-cooled portable chillers come standard with 4" (101 mm) swivel casters.

HP	Com-pressor hp	Process connections, in. NPT				Dimensions in inches ①			Weights		
		1 Pump to/from	2 Pump to/from	no pump, no tank	1 pump, no tank, to/from	height	width	depth	Dry ② lbs.	Ship. ② lbs.	Oper. ② ③ lbs.
20	2 @ 10	2" / 3"	2.5" / 3"	2.0"	2" / 3"	91.4	34.0	100.7	2,305	2,605	2,971
25	2 @ 13	2" / 3"	2.5" / 3"	2.0"	2" / 3"	91.4	34.0	100.7	2,348	2,648	3,014
30	2 @ 15	2" / 3"	2.5" / 3"	2.0"	2" / 3"	91.4	34.0	100.7	2,610	2,910	3,276

- ① To convert to cm, multiply by **2.54**. Add to height dimension based on mounting options.
- ② Weight is for standard chiller. Some optional features will increase weight. Multiply lbs. by **0.454** to calculate Kg.
- ③ Operating weight is with a full 80-gallon (303 liter) reservoir tank of water.

2 hp and 3.5 hp Water-Cooled Portable Chillers

Nominal operating parameters for water-cooled models are 50°F (10°C) leaving water temperature at 2.4 gpm per ton (9.1 lpm per 3.517 kW) with 85°F (29°C) tower water. **For 50 Hz applications, multiply capacity by 0.83. Nominal 60 Hz capacity flow rate must be maintained.**

HP	Nominal cooling capacity ① in tons		Nominal water flow gpm ②	Compressor hp	Nominal pump hp	Condenser water			Amp draws ⑤	
						Water conn. in. NPT	flow in gpm			
	no pump	1 pump					Tower water ③	City water ④	rated	running
2	2.1	1.9	5.1	2.0	1.0	1.0"	6.2	4.2	12.2	8.3
3.5	3.6	3.4	8.6	3.5	1.0	1.0"	10.5	7.2	16.4	11.8

- ① Based on 50°F (10°C) chilled water supply temperature and 85°F (29°C) tower water. Optional additional process pump hp (kW) reduces chiller capacity by 0.2 tons per hp (0.703 kW ref. cap. per 0.746 kW pump power).
- ② Based on 2.4 gpm per ton (9.1 lpm per 3.517 kW), nominal 1 pump.
- ③ Based on availability of 85°F (29°C) tower water at 25 psi (172.4 kPa/1.7 bars) minimum.
- ④ Based on availability of 70°F (21°C) city water at 25 psi (172.4 kPa/1.7 bars) minimum.
- ⑤ An optional oversized process pump adds to the total rated or running chiller amperage. To find the new total chiller amperage, subtract the standard process pump amperage from the optional pump amperage (see Figure 1 on page 16), and add it to the chiller rated or running amperage.
- ⑥ Multiply 460/3/60 amperage by 2.0 for 208-230/3/60 amperages.

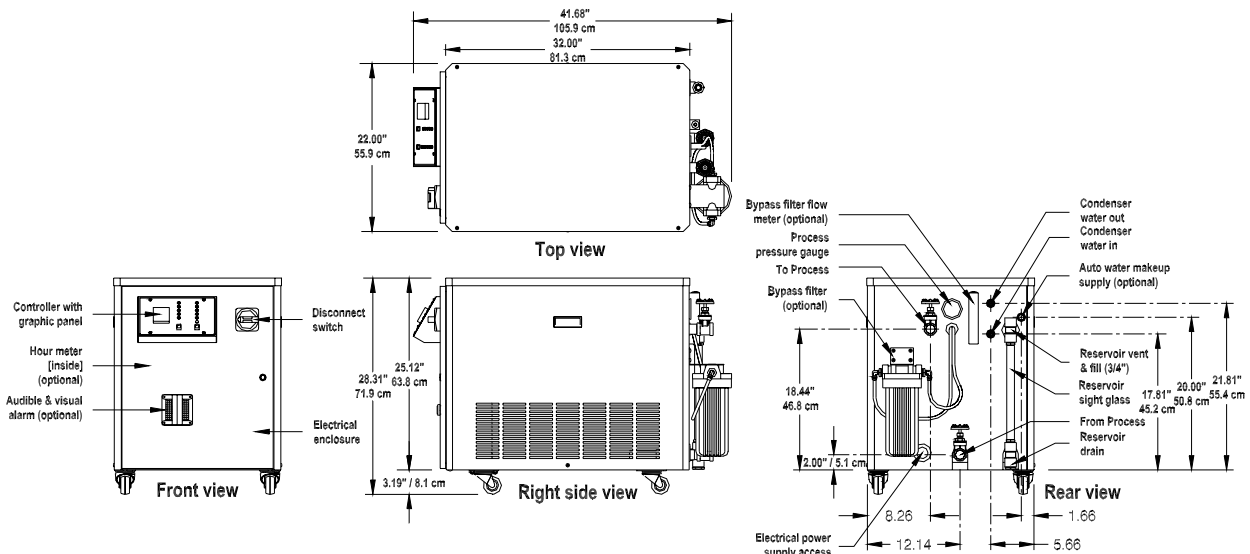

2 hp and 3.5 hp water-cooled portable chillers come standard with 2" (63 mm) swivel casters.

HP	Compressor hp	Process connections in. NPT	Dimensions in inches ①			Weights		
						Dry ②	Shipping ②	Operating ② ③
			height	width	depth	lbs.	lbs.	lbs.
2	2.0	1.0"	28.3"	22.0"	41.7"	333	363	383
3.5	3.5	1.0"	28.3"	22.0"	41.7"	362	392	412

- ① To convert to *cm*, multiply by **2.54**. Add to height dimension based on mounting options.
- ② Weight is for standard chiller. Some optional features will increase weight. Multiply by **0.454** to calculate *Kg*.
- ③ Operating weight is with a full 6-gallon (22.7 liter) reservoir tank of water.

5 hp and 7.5 hp Water-Cooled Portable Chillers

Nominal operating parameters for water-cooled models are 50°F (10°C) leaving water temperature at 2.4 gpm per ton (9.1 lpm per 3.517 kW) with 85°F (29°C) tower water. **For 50 Hz applications, multiply capacity by 0.83. Nominal 60 Hz capacity flow rate must be maintained.**

HP	Nominal cooling capacity ① tons			Nominal water flow gpm ②	Com-pressor hp	Nom. pump hp	Condenser water flow in gpm		Power in amps ⑤ 460/3/60 ⑥				
	no pump	1 pump	2 pump				Tower water ③	City water ④	1 pump		2 pumps		
									rated	running	rated	running	
5	5.2	5.0	4.9	12.6	5.0	1.0	1.0"	15.7	7.9	12.2	8.3	13.1	9.2
7.5	7.1	6.9	6.8	17.0	7.5	1.0	1.0"	21.3	10.7	16.4	11.8	17.3	12.7

- ① Based on 50°F (10°C) chilled water supply temperature and 85°F (29°C) tower water. Optional additional process pump hp reduces chiller capacity by 0.2 tons per hp (0.703 kW ref. cap. per 0.746 kW pump power).
- ② Based on 2.4 gpm per ton (9.1 lpm per 3.517 kW), nominal 1 pump.
- ③ Based on availability of 85°F (29°C) tower water at 25 psi (172.4 kPa/1.7 bars) minimum.
- ④ Based on availability of 70°F (21°C) city water at 25 psi (172.4 kPa/1.7 bars) minimum.
- ⑤ An optional oversized process pump adds to the total rated or running chiller amperage. To find the new total chiller amperage, subtract the standard process pump amperage from the optional pump amperage (see Figure 1 on page 16), and add it to the chiller rated or running amperage.
- ⑥ Multiply 460/3/60 amperage by **2.0** for 208-230/3/60 amperages.

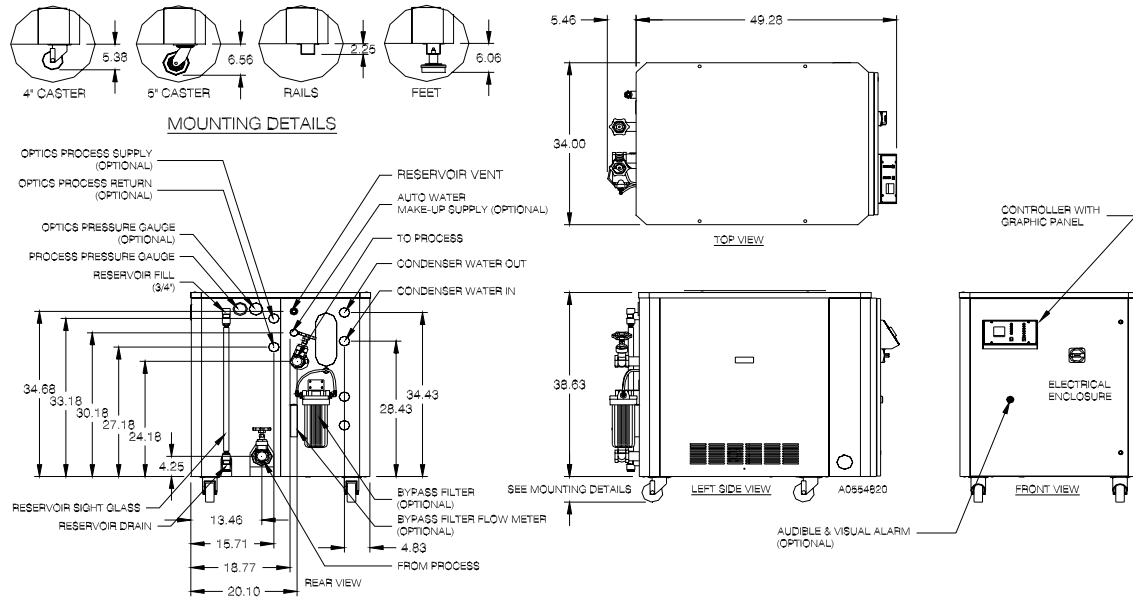

5 hp and 7.5 hp water-cooled chillers come standard with 4" (101 mm) swivel casters.

Com-pressor hp	Process connections, in. NPT				Dimensions in inches ①			Weights		
	1 pump	2 pumps	no pump, no tank	1 pump, no tank, to/from	height	width	depth	Dry ②	Ship. ②	Oper. ② ③
								lbs.	lbs.	lbs.
5.0	1.5"/2.0	2.0"	1.5"	1.5" / 2.0"	44.0"	34.0"	54.7"	637	787	970
7.5	1.5"/2.0	2.0"	1.5"	1.5" / 2.0"	44.0"	34.0"	54.7"	727	877	1,060

- ① To convert to *cm*, multiply by **2.54**. Add to height dimension based on mounting options.
- ② Weight is for standard chiller. Some optional features will increase weight. Multiply by **0.454** to calculate *Kg*.
- ③ Operating weight is with a full 20-gallon (76 liter) reservoir tank of water.

10 hp and 15 hp Water-Cooled Portable Chillers

Nominal operating parameters for water-cooled models are 50°F (10°C) leaving water temperature at 2.4 gpm per ton (9.1 lpm per 3.517 kW) with 85°F (29°C) tower water. **For 50 Hz applications, multiply capacity by 0.83. Nominal 60 Hz capacity flow rate must be maintained.**

HP	Nominal cooling capacity ① tons			Nominal water flow gpm ②	Compressor hp	Nom. pump hp	Condenser water			Power in amps ⑤					
	no pump	1 pump	2 pump				Water conn. in. NPT	flow in gpm		460/3/60 ⑥		1 pump		2 pumps	
								Tower water ③	City water ④	rated	running	rated	running		
10	10.7	10.3	10.2	25.7	10.0	2.0	1.5"	32.2	16.1	22.5	16.7	24.2	18.4		
15	15.9	15.5	15.3	38.1	15.0	2.0	2.0"	47.6	23.8	29.7	21.6	31.4	23.3		

- ① Based on 50°F (10°C) chilled water supply temperature and 85°F (29°C) tower water. Optional additional process pump hp reduces chiller capacity by 0.2 tons per hp (0.703 kW ref. cap. per 0.746 kW pump power).
- ② Based on 2.4 gpm per ton (9.1 lpm per 3.517 kW), nominal 1 pump.
- ③ Based on availability of 85°F (29°C) tower water at 25 psi (172.4 kPa/1.7 bars) minimum.
- ④ Based on availability of 70°F (21°C) city water at 25 psi (172.4 kPa/1.7 bars) minimum.
- ⑤ An optional oversized process pump adds to the total rated or running chiller amperage. To find the new total chiller amperage, subtract the standard process pump amperage from the optional pump amperage (see Figure 1 on page 16), and add it to the chiller rated or running amperage.
- ⑥ Multiply 460/3/60 amperage by **2.0** for 208-230/3/60 amperages.

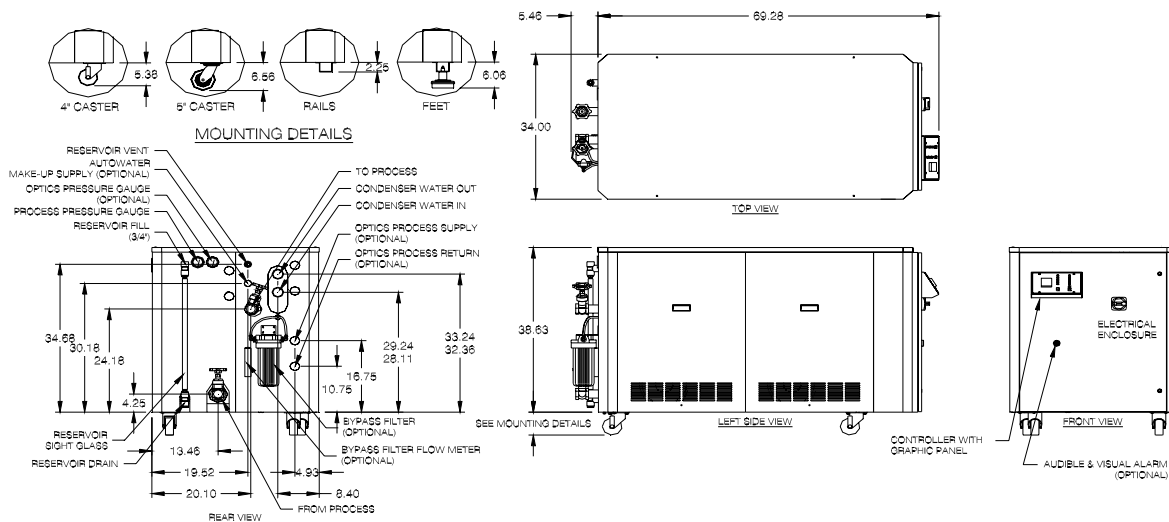

10 hp and 15 hp water-cooled chillers come standard with 4" (101 mm) swivel casters.

Compressor hp	Process connections, in. NPT				Dimensions in inches ①			Weights		
	1 Pump	2 pumps	no pump, no tank	1 pump, no tank, to/from	height	width	Depth	Dry ②	Ship. ②	Oper. ② ③
								lbs.	lbs.	lbs.
10.0	1.5"/3.0	2.0"/3.0	1.5"	1.5" / 2.0"	44.0"	34.0"	74.7"	950	1,175	1,282
15.0	2.0"/3.0	2.5"/3.0	2.0"	2.0" / 3.0"	44.0"	34.0"	74.7"	1,024	1,249	1,365

- ① To convert to *cm*, multiply by **2.54**. Add to height dimension based on mounting options.
- ② Weight is for standard chiller. Some optional features will increase weight. Multiply by **0.454** to calculate *Kg*.
- ③ Operating weight is with a full 40-gallon (151 liter) reservoir tank of water.

20 hp, 25 hp, and 30 hp Water-Cooled Portable Chillers

Nominal operating parameters for water-cooled models are 50°F (10°C) leaving water temperature at 2.4 gpm per ton (9.1 lpm per 3.517 kW) with 85°F (29°C) tower water. For 50 Hz applications, multiply capacity by 0.83. Nominal 60 Hz capacity flow rate must be maintained.

HP	Nominal cooling capacity ① tons			Nominal water flow gpm ②	Com-pressor hp	Nom. pump hp	Condenser water flow in gpm			Power in amps ⑤ 460/3/60 ⑥			
	no pump	1 pump	2 pump				Tower water ③	City water ④	1 pump		2 pumps		
									rated	running	rated	running	
20	21.0	20.0	19.6	50.4	2 @ 10	5.0	2.0"	61.7	31.5	43.9	34.7	47.0	37.8
25	25.7	24.7	24.3	61.7	2 @ 13	5.0	2.0"	75.9	38.6	55.9	38.2	59.0	41.3
30	31.8	30.8	30.4	76.2	2 @ 15	5.0	2.5"	93.9	47.6	60.1	45.3	63.2	48.4

- ① Based on 50°F (10°C) chilled water supply temperature and 85°F (29°C) tower water. Optional additional process pump hp reduces chiller capacity by 0.2 tons per hp (0.703 kW ref. cap. per 0.746 kW pump power).
- ② Based on 2.4 gpm per ton (9.1 lpm per 3.517 kW), nominal 1 pump.
- ③ Based on availability of 85°F (29°C) tower water at 25 psi (172.4 kPa/1.7 bars) minimum.
- ④ Based on availability of 70°F (21°C) city water at 25 psi (172.4 kPa/1.7 bars) minimum.
- ⑤ An optional oversized process pump adds to the total rated or running chiller amperage. To find the new total chiller amperage, subtract the standard process pump amperage from the optional pump amperage (see Figure 1 on page 16), and add it to the chiller rated or running amperage.
- ⑥ Multiply 460/3/60 amperage by 2.0 for 208-230/3/60 amperages.

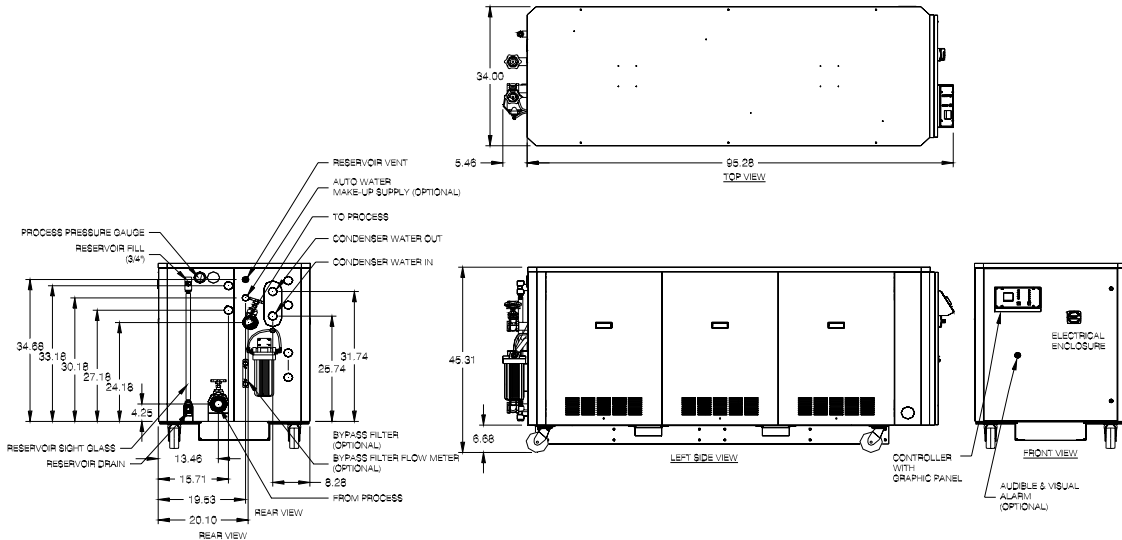

20 hp, 25 hp, and 30 hp water-cooled chillers come standard with 4" (101 mm) swivel casters.

HP	Com-pressor hp	Process connections, in. NPT				Dimensions in inches ①			Weights		
		1 pump to/from	2 Pump to/from	no pump, no tank	1 pump, no tank, to/from	height	width	depth	Dry ②	Ship. ②	Oper. ② ③
									lbs.	lbs.	lbs.
20	2 @ 10	2" / 3"	2.5" / 3"	2.0"	2" / 3"	45.3"	34.0"	100.7"	1,495	1,745	2,161
25	2 @ 13	2" / 3"	2.5" / 3"	2.0"	2" / 3"	45.3"	34.0"	100.7"	1,680	1,930	2,346
30	2 @ 15	2" / 3"	2.5" / 3"	2.0"	2" / 3"	45.3"	34.0"	100.7"	1,885	2,135	2,551

- ① To convert to cm, multiply by 2.54. Add to height dimension based on mounting options.
- ② Weight is for standard chiller. Some optional features will increase weight. Multiply by 0.454 to calculate Kg.
- ③ Operating weight is with a full 80-gallon (303 liter) reservoir tank of water.

35 hp and 40 hp Water-Cooled Portable Chillers

Nominal operating parameters for water-cooled models are 50°F (10°C) leaving water temperature at 2.4 gpm per ton (9.1 lpm per 3.517 kW) with 85°F (29°C) tower water. **For 50 Hz applications, multiply capacity by 0.83. Nominal 60 Hz capacity flow rate must be maintained.**

HP	Nominal cooling capacity ① tons			Nominal water flow gpm ②	Compressor hp	Nom. pump hp	Condenser water			Power in amps ⑤ 460/3/60 ⑥			
	no pump	1 pump	2 pump				Water conn. in. NPT	flow in gpm		1 pump		2 pumps	
								Tower water ③	City water ④	rated	running	rated	running
35	34.2	32.7	32.3	82.0	35	7.5	2.5"	102.5	51.3	64.4	55.7	67.5	58.8
40	41.0	39.5	39.1	98.4	40	7.5	2.5"	123.0	61.5	81.9	63.1	85.0	66.2

- ① Based on 50°F (10°C) chilled water supply temperature and 85°F (29°C) tower water. Optional additional process pump hp reduces chiller capacity by 0.2 tons per hp (0.703 kW ref. cap. per 0.746 kW pump power).
- ② Based on 2.4 gpm per ton (9.1 lpm per 3.517 kW), nominal 1 pump.
- ③ Based on availability of 85°F (29°C) tower water at 25 psi (172.4 kPa/1.7 bars) minimum.
- ④ Based on availability of 70°F (21°C) city water at 25 psi (172.4 kPa/1.7 bars) minimum.
- ⑤ An optional oversized process pump adds to the total rated or running chiller amperage. To find the new total chiller amperage, subtract the standard process pump amperage from the optional pump amperage (see Figure 1 on page 16), and add it to the chiller rated or running amperage.
- ⑥ Multiply 460/3/60 amperage by **2.0** for 208-230/3/60 amperages.

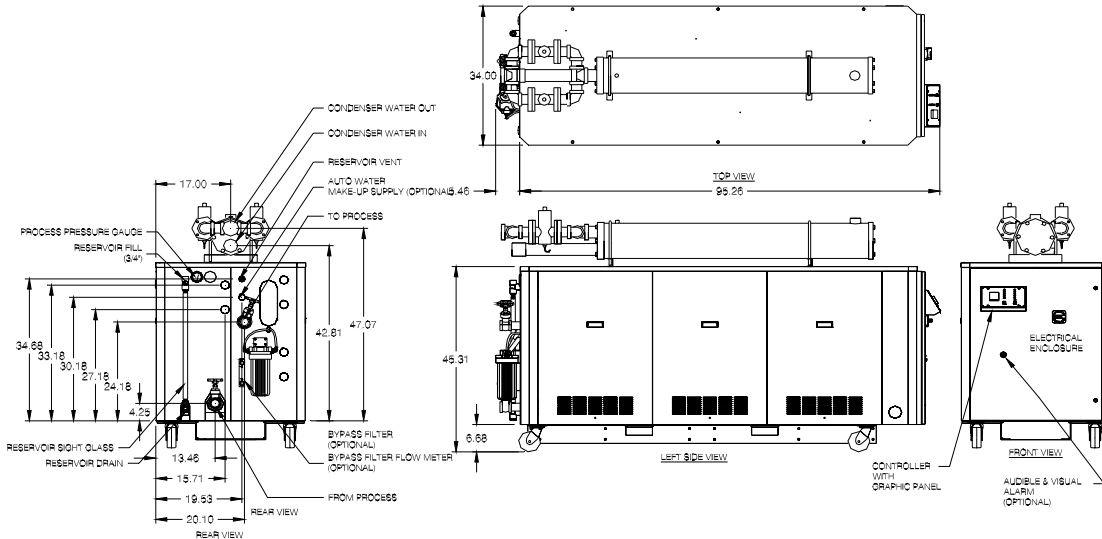

35 hp and 40 hp water-cooled chillers come standard with 4" (101 mm) swivel casters.

Compressor hp	Process connections, in. NPT				Dimensions in inches ①			Weights		
	1 pump to/from	2 Pump to/from	no pump, no tank	1 pump, no tank, to/from	height	width	depth	Dry ②	Ship. ②	Oper. ② ③
								lbs.	lbs.	lbs.
35	2.5" / 3"	2.5" / 3"	2.5"	2.5" / 3"	59.9"	34.0"	100.7"	2,669	2,919	3,358
40	2.5" / 3"	2.5" / 3"	2.5"	2.5" / 3"	59.9"	34.0"	100.7"	2,680	2,930	3,369

- ① To convert to *cm*, multiply by **2.54**. Add to height dimension based on mounting options.
- ② Weight is for standard chiller. Some optional features will increase weight. Multiply by **0.454** to calculate *Kg*.
- ③ Operating weight is with a full 80-gallon (303 liter) reservoir tank of water.

5 hp and 7.5 hp Remote Air-Cooled Portable Chillers

Nominal operating parameters for remote air-cooled models are 50°F (10°C) leaving water temperature at 2.4 gpm per ton (9.1 lpm per 3.517 kW) with 95°F (35°C) ambient air. **For 50 Hz applications**, multiply capacity by **0.83**. *Nominal 60 Hz capacity flow rate must be maintained.*

HP	Nominal cooling capacity ① tons			Nom. water flow gpm ②	Com-pressor hp	Nom. pump hp	Refrigeration connections		Power in amps ③ 460/3/60 ④			
	no pump	1 pump	2 pump				in. dia. ODS		1 pump		2 pumps	
							Discharge	Liquid	rated	running	rated	running
5	4.8	4.6	4.5	11.6	5.0	1.0	5/8"	5/8"	12.2	9.2	13.1	10.1
7.5	6.6	6.4	6.3	15.7	7.5	1.0	7/8"	5/8"	16.2	12.8	17.3	13.7

- ① Based on 50°F (10°C) chilled water supply temperature and 95°F (35°C) ambient air. Optional additional process pump hp reduces chiller capacity by 0.2 tons per hp (0.703 kW ref. cap. per 0.746 kW pump power).
- ② Based on 2.4 gpm per ton (9.1 lpm per 3.517 kW), nominal 1 pump.
- ③ An optional oversized process pump adds to the total rated or running chiller amperage. To find the new total chiller amperage, subtract the standard process pump amperage from the optional pump amperage (see Figure 1 on page 16), and add it to the chiller rated or running amperage.
- ④ Multiply 460/3/60 amperage by **2.0** for 208-230/3/60 amperages; multiply by **0.8** for 575/3/60 amperages.

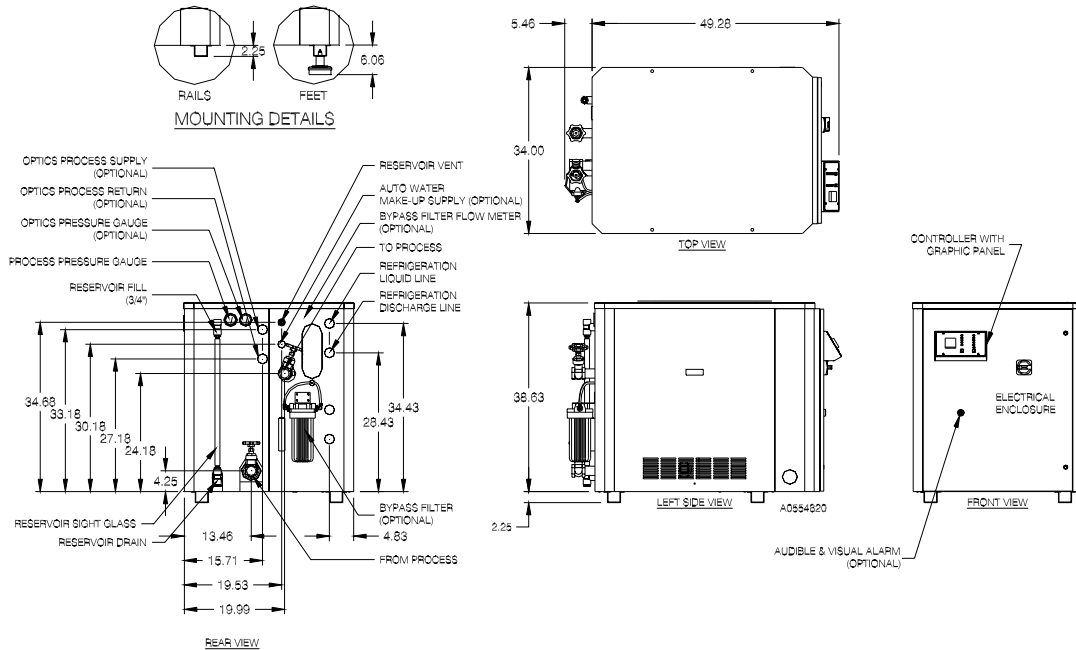

Remote air-cooled portable chillers come standard with mounting rails. Remote air-cooled portable chillers are charged with 25 psi (172.4 kPa/1.72 bars) nitrogen for shipping purposes.

Com-pressor hp	Process connections, in. NPT				Dimensions in inches ①			Weights		
	1 pump	2 pumps	no pump, no tank	1 pump, no tank, to/from	height	width	depth	Dry ②	Ship. ②	Oper. ② ③
								lbs.	lbs.	lbs.
5.0	1.5"	2.0"	1.5"	1.5" / 2.0"	40.9"	34.0"	54.7"	597	748	930
7.5	1.5"	2.0"	1.5"	1.5" / 2.0"	40.9"	34.0"	54.7"	644	794	977

- ① To convert to *cm*, multiply by **2.54**. Add to height dimension based on mounting options.
- ② Weight is for standard chiller. Some optional features will increase weight.
- ③ Operating weight is with a full 20-gallon (76 liter) reservoir tank of water.

10 hp and 15 hp Remote Air-Cooled Portable Chillers

Nominal operating parameters for remote air-cooled models are 50°F (10°C) leaving water temperature at 2.4 gpm per ton (9.1 lpm per 3.517 kW) with 95°F (35°C) ambient air. **For 50 Hz applications**, multiply capacity by **0.83**. *Nominal 60 Hz capacity flow rate must be maintained.*

HP	Nominal cooling capacity ① tons			Nom. water flow gpm ②	Com-pressor hp	Nom. pump hp	Refrigeration connections		Power in amps ③ 460/3/60 ④			
	no pump	1 pump	2 pump				in. dia. ODS		1 pump		2 pumps	
							Discharge	Liquid	rated	running	rated	running
10	9.9	9.5	9.4	23.8	10.0	2.0	1 1/8"	5/8"	22.5	18.2	24.2	19.9
15	14.5	14.1	14.0	34.9	15.0	2.0	1 1/8"	5/8"	29.7	23.9	31.4	25.6

- ① Based on 50°F (10°C) chilled water supply temperature and 95°F (35°C) ambient air. Optional additional process pump hp reduces chiller capacity by 0.2 tons per hp (0.703 kW ref. cap. per 0.746 kW pump power).
- ② Based on 2.4 gpm per ton (9.1 lpm per 3.517 kW), nominal 1 pump.
- ③ An optional oversized process pump adds to the total rated or running chiller amperage. To find the new total chiller amperage, subtract the standard process pump amperage from the optional pump amperage (see Figure 1 on page 16), and add it to the chiller rated or running amperage.
- ④ Multiply 460/3/60 amperage by **2.0** for 208-230/3/60 amperages; multiply by **0.8** for 575/3/60 amperages.

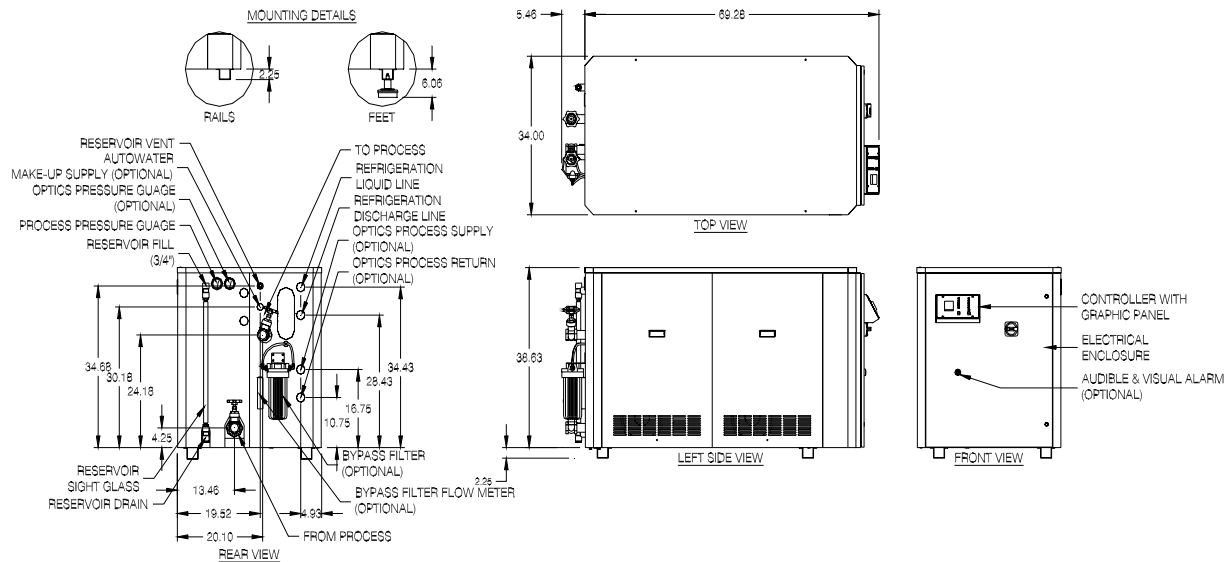

Remote air-cooled portable chillers come standard with mounting rails. Remote air-cooled portable chillers are charged with 25 psi (172.4 kPa/1.72 bars) nitrogen for shipping purposes.

Com-pressor hp	Process connections, in. NPT				Dimensions inches ①			Weights		
	1 pump	2 pumps	no pump, no tank	1 pump, no tank, to/from	height	width	Depth	Dry ②	Ship. ②	Oper. ② ③
								lbs.	lbs.	lbs.
10.0	1.5"	2.0"	1.5"	1.5" / 2.0"	40.9"	34.0"	74.7"	827	1,052	1,159
15.0	2.0"	2.5"	2.0"	2.0" / 3.0"	40.9"	34.0"	74.7"	870	1,095	1,202

- ① To convert to *cm*, multiply by **2.54**. Add to height dimension based on mounting options.
- ② Weight is for standard chiller. Some optional features will increase weight.
- ③ Operating weight is with a full 40-gallon (151 liter) reservoir tank of water.

20 hp through 40 hp Remote Air-Cooled Portable Chillers

Nominal operating parameters for remote air-cooled models are 50°F (10°C) leaving water temperature at 2.4 gpm per ton (9.1 lpm per 3.517 kW) with 95°F (35°C) ambient air. **For 50 Hz applications**, multiply capacity by **0.83**. *Nominal 60 Hz capacity flow rate must be maintained.*

HP	Nominal cooling capacity ① tons			Nom. water flow gpm ②	Compressor hp	Nom. pump hp	Refrigeration connections		Power in amps ③ 460/3/60 ④			
	no pump	1 pump	2 pump				in. dia. ODS		1 pump		2 pumps	
							Discharge	Liquid	rated	running	rated	running
20	19.4	18.4	18.0	46.5	2 @ 10	5	1 3/8"	7/8"	43.9	37.6	47.0	40.7
25	23.8	22.8	22.4	57.2	2 @ 13	5	1 3/8"	7/8"	55.9	42.1	59.0	45.2
30	29.2	28.2	27.8	70.2	2 @ 15	5	1 3/8"	7/8"	60.0	50.4	63.2	53.5
35	30.6	29.1	28.7	73.5	35	7.5	1 5/8"	1 1/8"	64.4	60.3	67.5	63.4
40	36.9	35.4	35.0	88.6	40	7.5	1 5/8"	1 1/8"	81.9	68.8	85.0	58.0

① Based on 50°F (10°C) chilled water supply temperature and 95°F (35°C) ambient air. Optional additional process pump hp reduces chiller capacity by 0.2 tons per hp (0.703 kW ref. cap. per 0.746 kW pump power).

② Based on 2.4 gpm per ton (9.1 lpm per 3.517 kW), nominal 1 pump.

③ An optional oversized process pump adds to the total rated or running chiller amperage. To find the new total chiller amperage, subtract the standard process pump amperage from the optional pump amperage (see Figure 1 on page 16), and add it to the chiller rated or running amperage.

④ Multiply 460/3/60 amperage by **2.0** for 208-230/3/60 amperages; multiply by **0.8** for 575/3/60 amperages.

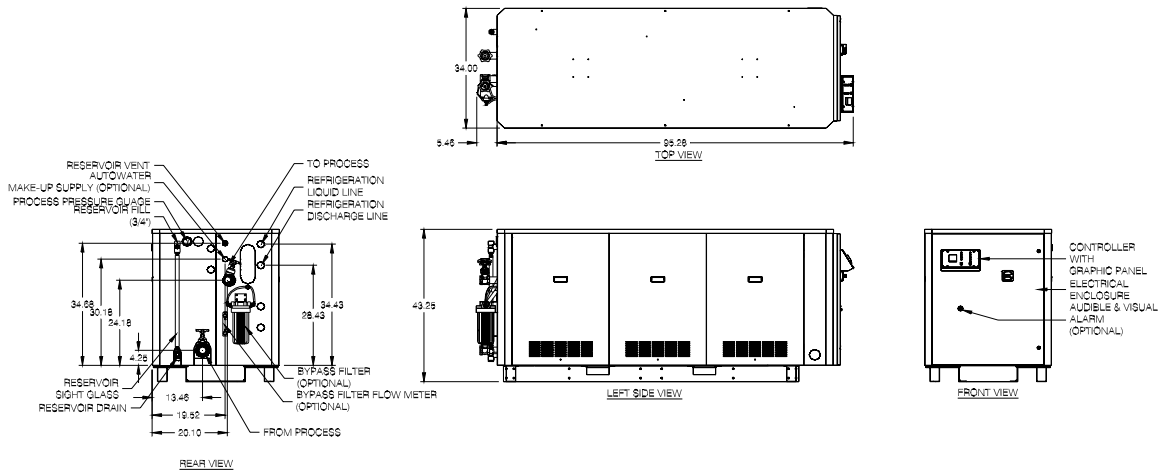

Remote air-cooled portable chillers come standard with mounting rails. Remote air-cooled portable chillers are charged with 25 psi (172.4 kPa/1.72 bars) nitrogen for shipping purposes.

HP	Compressor hp	Process connections, in. NPT				Dimensions in inches ①			Weights		
		1 pump to/from	2 Pump to/from	no pump, no tank	1 pump, no tank, to/from	height	width	depth	Dry ②	Ship. ②	Oper. ② ③
									lbs.	lbs.	lbs.
20	2 @ 10	2" / 3"	2.5" / 3"	2.0"	2" / 3"	43.3"	34.0"	100.7"	1,299	1,549	1,965
25	2 @ 13	2" / 3"	2.5" / 3"	2.0"	2" / 3"	43.3"	34.0"	100.7"	1,305	1,555	1,971
30	2 @ 15	2" / 3"	2.5" / 3"	2.0"	2" / 3"	43.3"	34.0"	100.7"	1,607	1,857	2,273
35	35	2.5" / 3"	2.5" / 3"	2.5"	2.5" / 3"	43.3"	34.0"	100.7"	2,235	2,462	2,901
40	40	2.5" / 3"	2.5" / 3"	2.5"	2.5" / 3"	43.3"	34.0"	100.7"	2,243	2,470	2,909

① To convert to *cm*, multiply by **2.54**. Add to height dimension based on mounting options.

② Weight is for standard chiller. Some optional features will increase weight.

③ Operating weight is with a full 80-gallon (303 liter) reservoir tank of water.

Remote Condenser Assembly Models

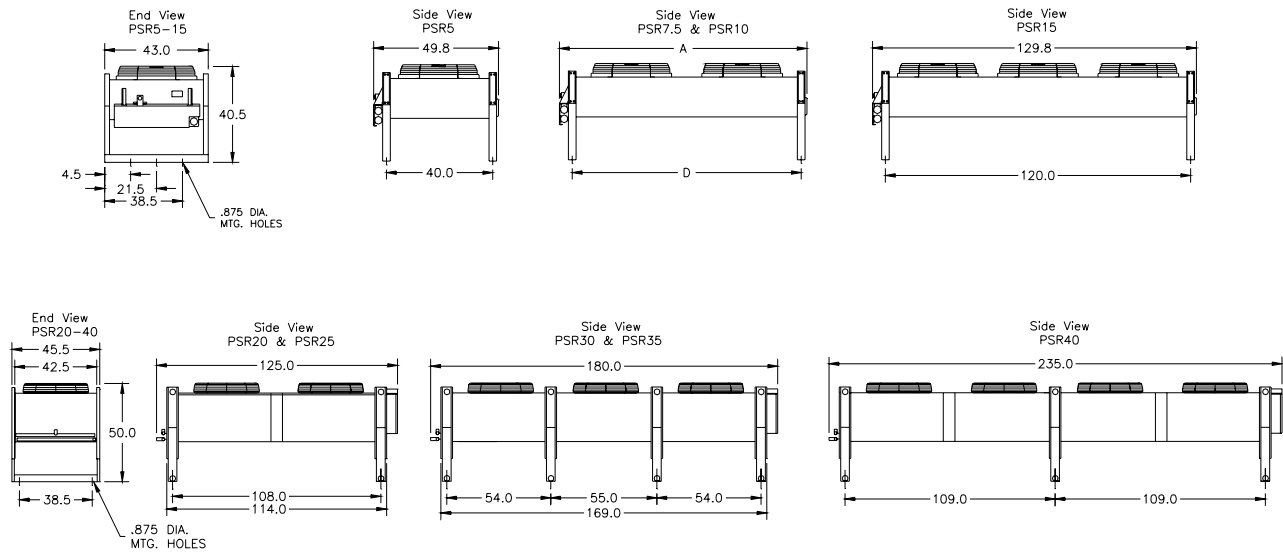

To convert inches to *cm*, multiply dimension by **2.54**.

HP	Fan(s) ② ③ ④						Remote Condenser				Refrigeration ⑤		
	Each			Totals ③ ④			Overall Dimensions				Connections		Charge R-22 lbs. ⑤
	Dia. in.	Motor hp ①	Amps 460V	Fans	Air flow cfm ⑥	Net wt. lbs. ⑥	Length 'A'(in.)	Width 'B'(in.)	Height 'C'(in.)	Mtg. 'D'(in.)	Discharge ODS(in.)	Liquid ODS(in.)	
5	26	3/4 hp 1 ø	2.4	1	6,450	260	49.8	43.0	40.5	40.0	1 1/8	7/8	3.6
7.5	26	1/3 hp 3 ø	3.7	2	12,400	470	69.8	43.0	40.5	60.0	1 1/8	7/8	3.6
10	26	1/3 hp 3 ø	3.7	2	13,700	510	89.8	43.0	40.5	80.0	1 3/8	1 1/8	4.6
15	26	1/3 hp 3 ø	5.0	3	20,500	550	129.8	43.0	40.5	120.0	1 5/8	1 1/8	6.4
20	30	1 1/2 hp 3 ø	5.9	2	23,000	840	125.0	45.5	50.0	108.0	1 5/8	1 5/8	10.0
25	30	1 1/2 hp 3 ø	5.9	2	21,900	860	125.0	45.5	50.0	108.0	1 5/8	1 5/8	16.0
30	30	1 1/2 hp 3 ø	9.4	3	34,800	1,280	180.0	45.5	50.0	⑦	2 1/8	2 1/8	24.0
35	30	1 1/2 hp 3 ø	9.4	3	32,900	1,300	180.0	45.5	50.0	⑦	2 1/8	2 1/8	24.0
40	30	1 1/2 hp 3 ø	12.9	4	46,400	1,690	235.0	45.5	50.0	⑦	2 1/8	2 1/8	29.0

① ø represents electrical phase; all motors are 1,140 rpm. Multiply hp by **0.746** to convert to *kW*.

② All first fan motors (Header Side) are 3/4 hp (0.56 *kW*) single phase variable speed.

③ Multiply 460V amperages by **2.0** for 208-230V amperages.

④ Multiply 460 V amperages by **0.8** for 575 V amperages.

⑤ Refrigeration charge is for **remote condenser only!**

⑥ To convert cfm to *cmh*, multiply by **1.699**. To convert lbs. to *Kg*, multiply by **0.454**.

⑦ See drawing above.

7-4 Pump Curves, Flow, and Pressure Considerations

60 Hertz Pump Curves

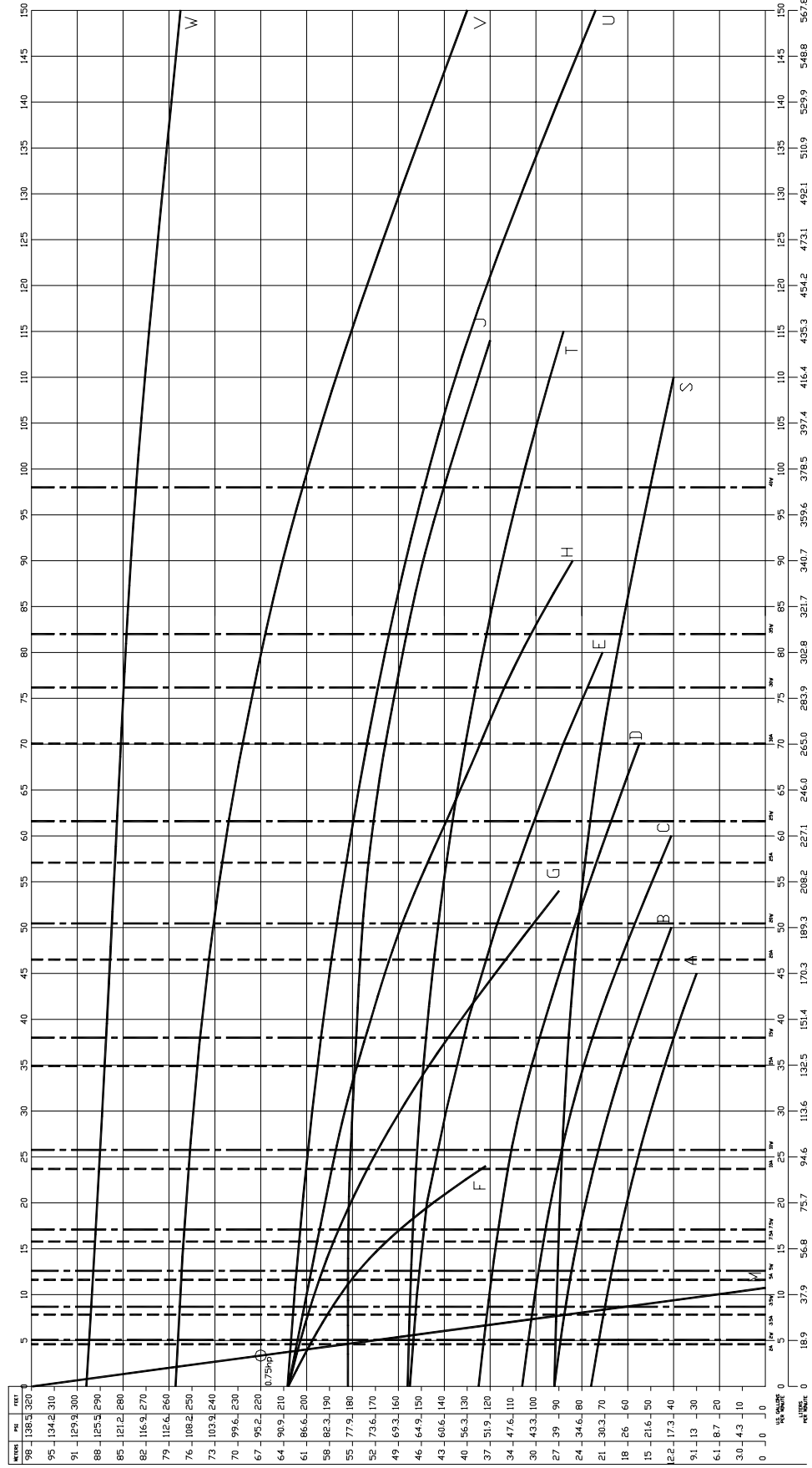

DWG. No. A0554823

50 Hertz Pump Curves

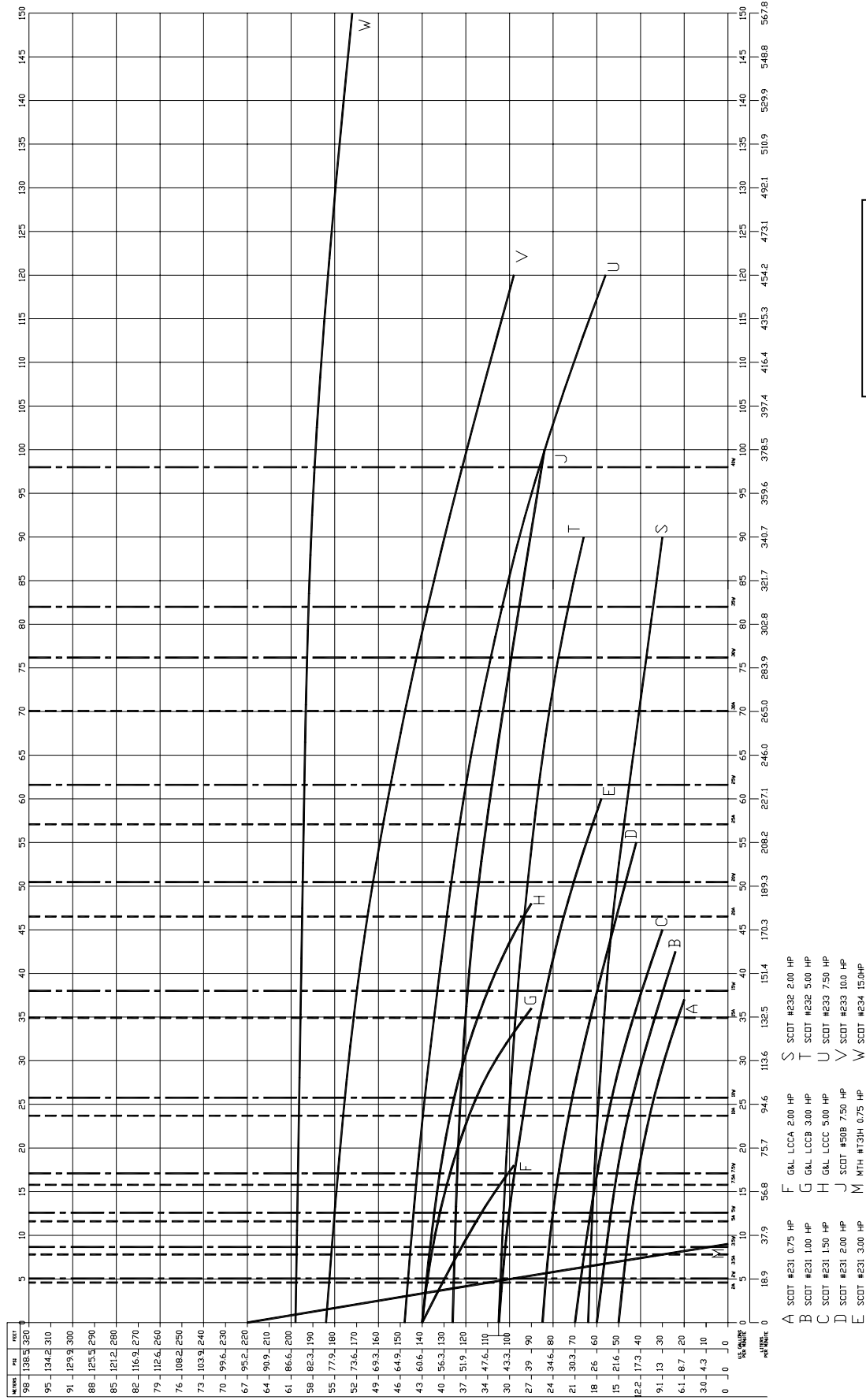

DWG. No. S0554823

Water Pressure Drop Tables

Note: A recirculation pump is required for flows greater than the maximum or less than the minimum indicated.

Note: Process flow less than or greater than the flow rates shown below requires a recirculation pump.

Pressure drops in ΔP , psig and kPa															
2 HP				3.5 HP				5 HP				7.5 HP			
Flow		ΔP		Flow		ΔP		Flow		ΔP		Flow		ΔP	
gpm	lpm	psig	kPa	gpm	lpm	psig	kPa	gpm	lpm	psig	kPa	gpm	lpm	psig	kPa
4.06	15.4	3.5	24.1	8.03	30.4	4.0	27.6	10.0	37.9	1.5	10.5	12.0	45.4	2.3	16.1
6.01	22.8	7.0	48.3	10.00	37.9	6.5	44.8	12.0	45.4	2.2	14.8	16.0	60.6	2.9	20.1
8.02	30.4	11.5	79.3	12.00	45.4	10.0	69.	18.0	68.1	4.7	32.1	20.0	75.7	5.0	34.5
10.00	37.9	18.0	124.1	14.00	53.0	13.0	89.6	24.0	90.8	7.3	50.2	24.0	90.8	6.9	47.4
				16.00	60.6	18.0	124.1					28.0	106.0	9.6	65.9
												33.0	124.9	12.7	87.8
10 HP				15 HP				20 HP				25 HP			
Flow		ΔP		Flow		ΔP		Flow		ΔP		Flow		ΔP	
gpm	lpm	psig	kPa	gpm	lpm	psig	kPa	gpm	lpm	psig	kPa	gpm	lpm	psig	kPa
22.0	83.3	4.7	32.6	30.0	113.6	4.5	31.3	40.0	151.4	4.0	27.6	55.0	208.2	5.5	37.9
30.0	113.6	8.28	57.1	40.0	151.4	7.5	51.7	45.0	170.3	4.0	27.6	58.0	219.5	5.8	40.0
38.0	143.8	12.91	89.0	50.0	189.3	12.4	85.2	50.0	189.3	5.0	34.5	61.0	230.9	6.0	41.4
46.0	174.1	16.77	115.6	60.0	227.1	17.8	122.8	52.0	196.8	6.0	41.4	70.0	264.9	8.5	58.6
50.0	189.3	20.00	137.9	70.0	264.9	24.2	166.6	55.0	208.2	6.5	44.8				
30 HP				35 HP				40 HP							
Flow		ΔP		Flow		ΔP		Flow		ΔP		Flow		ΔP	
gpm	lpm	psig	kPa	gpm	lpm	psig	kPa	gpm	lpm	psig	kPa	gpm	lpm	psig	kPa
72.0	272.5	6.0	41.1	38.7	146.5	1.5	10.4	92.6	350.5	7.9	54.5	44.7	169.2	2.0	13.8
75.0	283.9	6.5	44.8	51.2	193.8	2.6	17.9	107.1	405.4	10.4	71.7	58.5	221.4	3.4	23.4
80.0	302.8	8.0	55.2	62.3	235.8	3.8	26.2					70.9	268.3	4.9	33.8
85.0	321.7	9.5	65.5	71.8	271.7	4.9	33.8					81.6	308.8	6.3	43.5
				82.9	313.7	6.5	44.8					105.7	400.0	10.3	71.0

Note: These pressure drop values are valid for single- and no-pump portable chillers.

Calculating Chiller Nominal Flow and Pressure to Process

- **Flow rate:** Obtain the flow reading from the appropriate pump curve.
- **Pressure:** Obtain a corresponding pressure reading from the pump curve you selected, then **subtract** the one-pump pressure drop listed in the above table using the appropriate chiller hp and flow rate.
- For two-pump (Process/Recirc) chillers, do not subtract pressure drop from table above for process pump.

Flow and Pressure Considerations

Model ^①	Design flow		Design Δ P		Standard pump power		To Process pressure		
	gpm	lpm	psig	kPa	hp	kW	psi	kPa	bars
-A, 2 hp	4.6	17.5	4.4	30.4	1	0.746	34.1	235.3	2.4
-A, 3.5 hp	7.9	29.9	4.9	33.7	1	0.746	33.0	227.5	2.3
-A, -R, 5 hp	11.6	43.8	2.0	13.7	1	0.746	34.9	240.8	2.4
-A, -R, 7.5 hp	15.7	59.6	2.8	19.0	1	0.746	32.7	225.7	2.3
-A, -R, 10 hp	23.8	90.1	5.1	35.2	2	1.492	43.4	299.0	3.0
-A, -R, 15 hp	34.9	132.1	6.1	41.8	2	1.492	38.0	262.1	2.6
-A, -R, 20 hp	46.5	175.9	7.1	49.0	5	3.73	54.0	372.3	3.7
-A, -R, 25 hp	57.2	216.4	8.1	55.9	5	3.73	52.0	358.5	3.6
-A, -R, 30 hp	70.2	265.6	10.5	72.4	5	3.73	47.5	327.5	3.3
-R 35 hp	73.5	278.2	5.4	37.2	7.5	5.59	64.0	441.3	4.4
-R 40 hp	88.6	335.4	8.2	56.5	7.5	5.59	55.0	379.2	3.8
<hr/>									
-W 2 hp	5.1	19.1	5.7	39.1	1	0.746	32.9	226.6	2.3
-W 3.5 hp	8.6	32.7	6.0	41.2	1	0.746	31.7	218.5	2.2
-W 5 hp	12.6	47.7	2.3	16.00	1	0.746	34.3	236.2	2.4
-W 7.5 hp	17.0	64.5	3.1	21.4	1	0.746	32.0	220.3	2.2
-W 10 hp	25.7	97.4	6.3	43.3	2	1.492	41.4	285.3	2.9
-W 15 hp	38.1	144.1	7.0	48.1	2	1.492	35.5	244.4	2.4
-W 20 hp	50.4	190.8	8.8	60.3	5	3.73	52.0	358.5	3.6
-W 25 hp	61.7	233.7	9.0	62.1	5	3.73	49.0	337.9	3.4
-W 30 hp	76.2	288.5	10.8	74.1	5	3.73	43.0	296.5	3.0
-W 35 hp	82.0	310.4	5.4	37.2	7.5	5.59	64.0	441.3	4.4
-W 40 hp	98.4	372.4	8.2	56.5	7.5	5.59	55.0	379.2	3.8

① -A – Air-cooled; -W – Water-cooled; -R – Remote Air-cooled.

Note: *Pressure is proportional to flow. Recirculation pump is required for values exceeding those listed.*

Recirculation Pump Specifications

HP	Recirc. power		Flow Rate		Δ pressure	
	hp	kW	gpm	lpm	psi	kPa
5	0.75	0.373	13.0	49.2	2.3	16.0
7.5	0.75	0.373	17.0	64.3	3.1	21.4
10	0.75	0.595	26.0	98.4	6.3	43.3
15	0.75	0.595	38.0	143.8	7.0	48.0
20	2.0	1.492	50.0	189.2	8.8	60.3
25	2.0	1.492	63.0	238.4	9.0	62.0
30	2.0	1.492	76.0	287.6	10.8	74.1
35	3.0	2.238	82.0	310.4	5.4	37.2
40	3.0	2.238	98.0	370.9	8.2	56.5

7-5 Remote Air-Cooled Chiller Configurations

Configuration A:

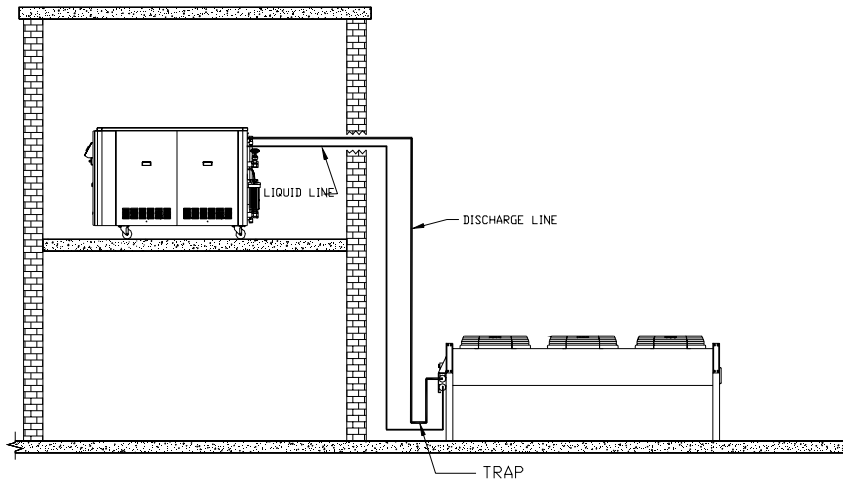

*Liquid line riser should not exceed 15 feet from base of air-cooled condenser.

Configuration B:

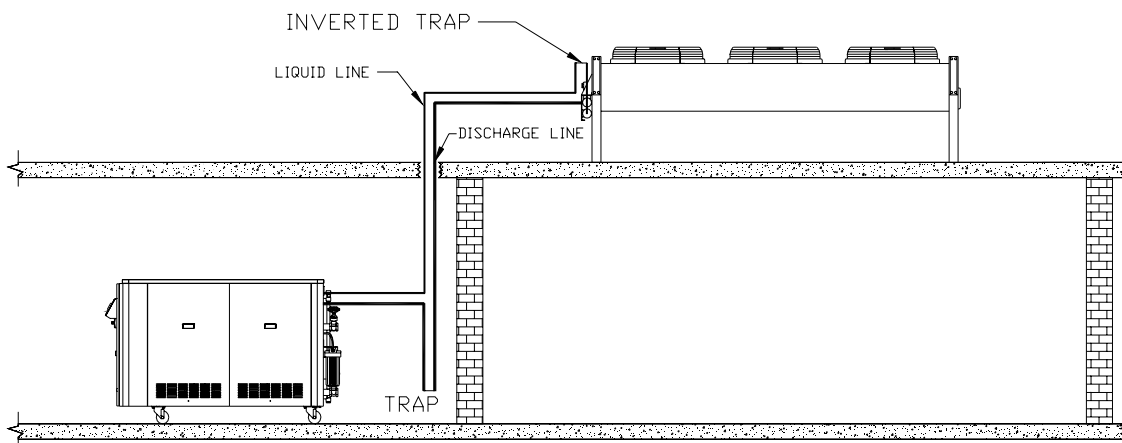

Configuration C:

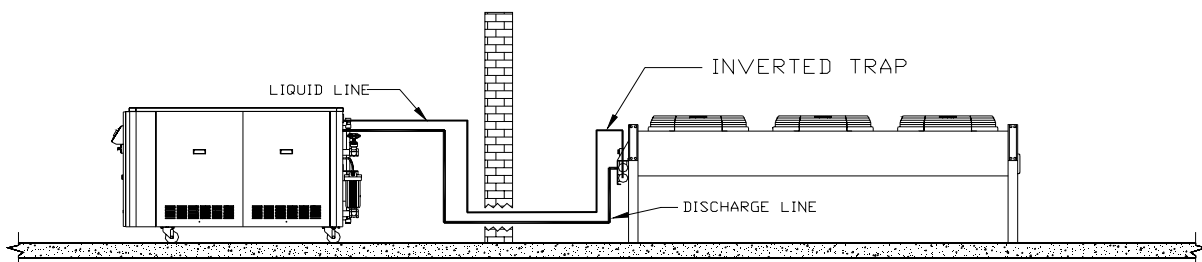

7-6 Typical Ductwork for Air-Cooled Chillers

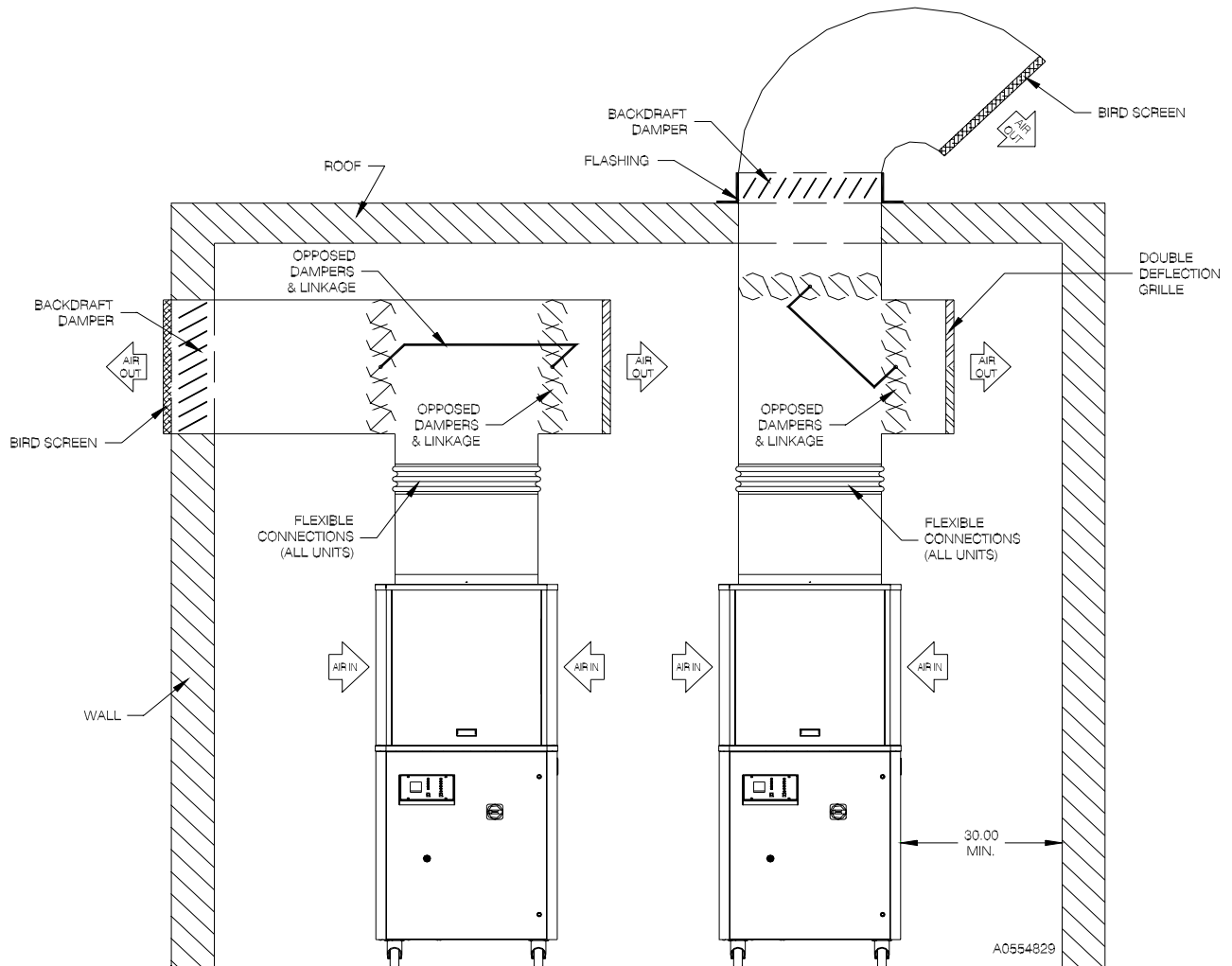

*See specification tables on pages 45-48 for air flow and pressure capacities.

When locating your air-cooled portable chiller and designing its ductwork, note any potential high temperature conditions when discharging into your building and any negative pressures with the building when discharging air outside.

Notes:

- Customer use of ductwork requires the high pressure fan option for models 5 through 15 hp.
- Allow 30" (77 cm) minimum clearance around the chiller footprint to facilitate free passage of cooling air and service accessibility
- Size the ductwork for maximum capacity
- Support ductwork from the building structure, not off of the chiller
- Back draft damper to outside must be closed at all times when fan/blower is not operating
- Chillers with dual fans/blower must have a back draft damper on the cycling fan/blower to prevent recirculation of hot discharge air
- Chillers are designed to operate at a condensing entering air temperature of 60°F (16°C) minimum
- Maximum total static pressure drop external to the chiller must not exceed 0.30" WG (75 pa)

7-7 Piping Diagrams

Central and Gravity Return Piping with Standpipe Diagram

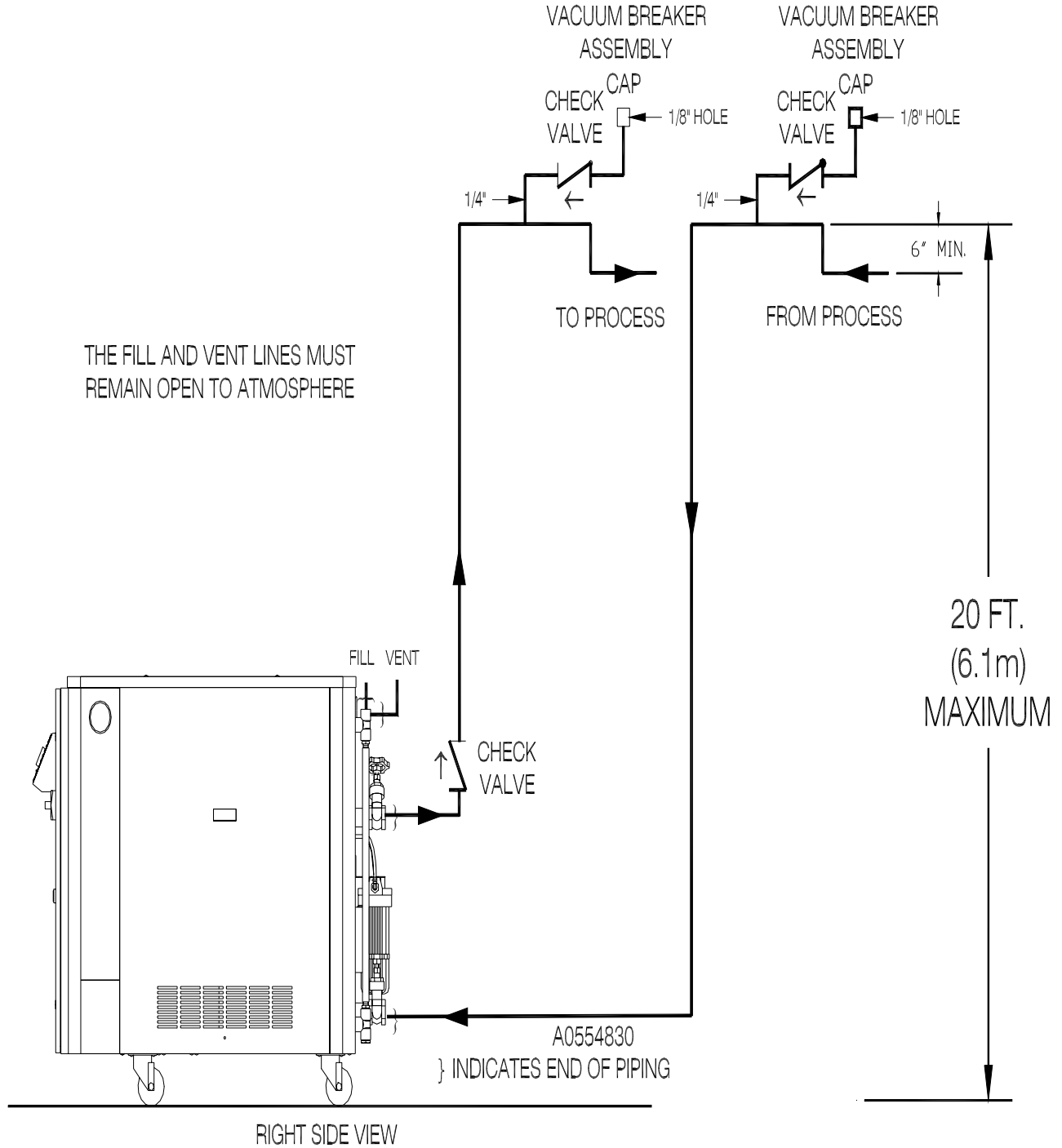

Typical Piping Schematic, 2 and 3 1/2 hp Models

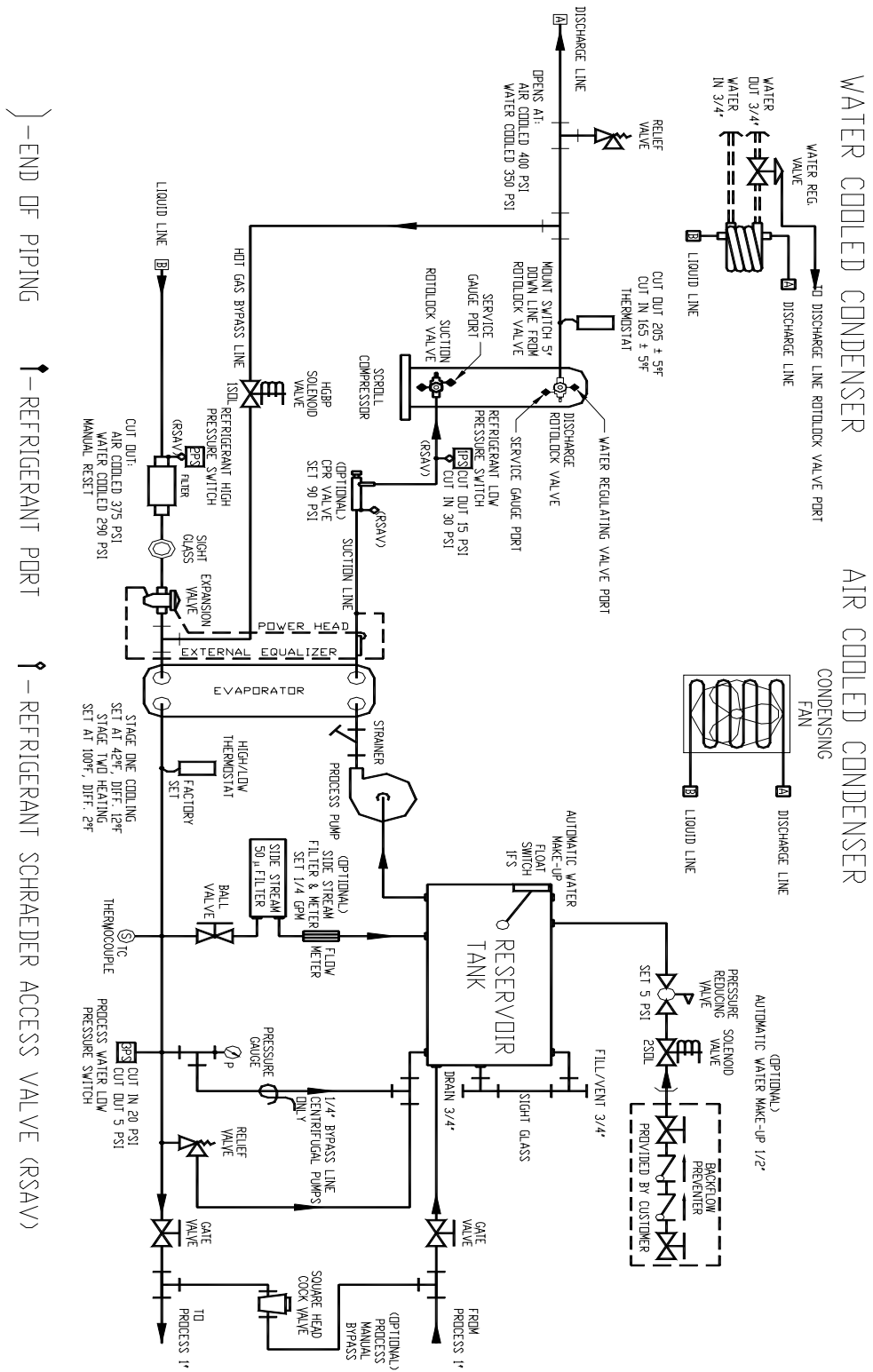

Typical Piping Schematic, 5 hp through 40 hp, One-Pump Models

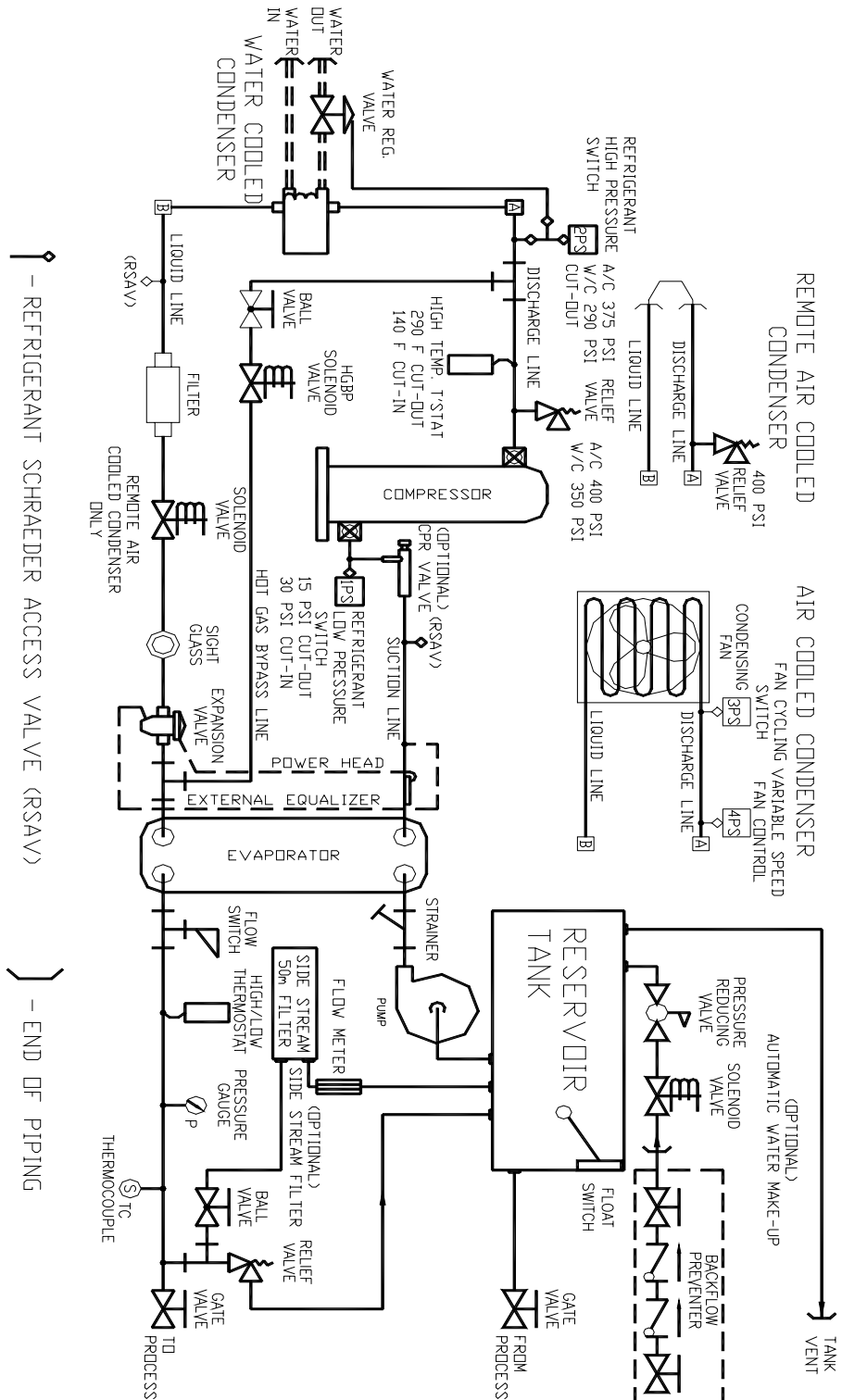

Typical Piping Schematic, 5 hp through 40 hp, Two-Pump Models

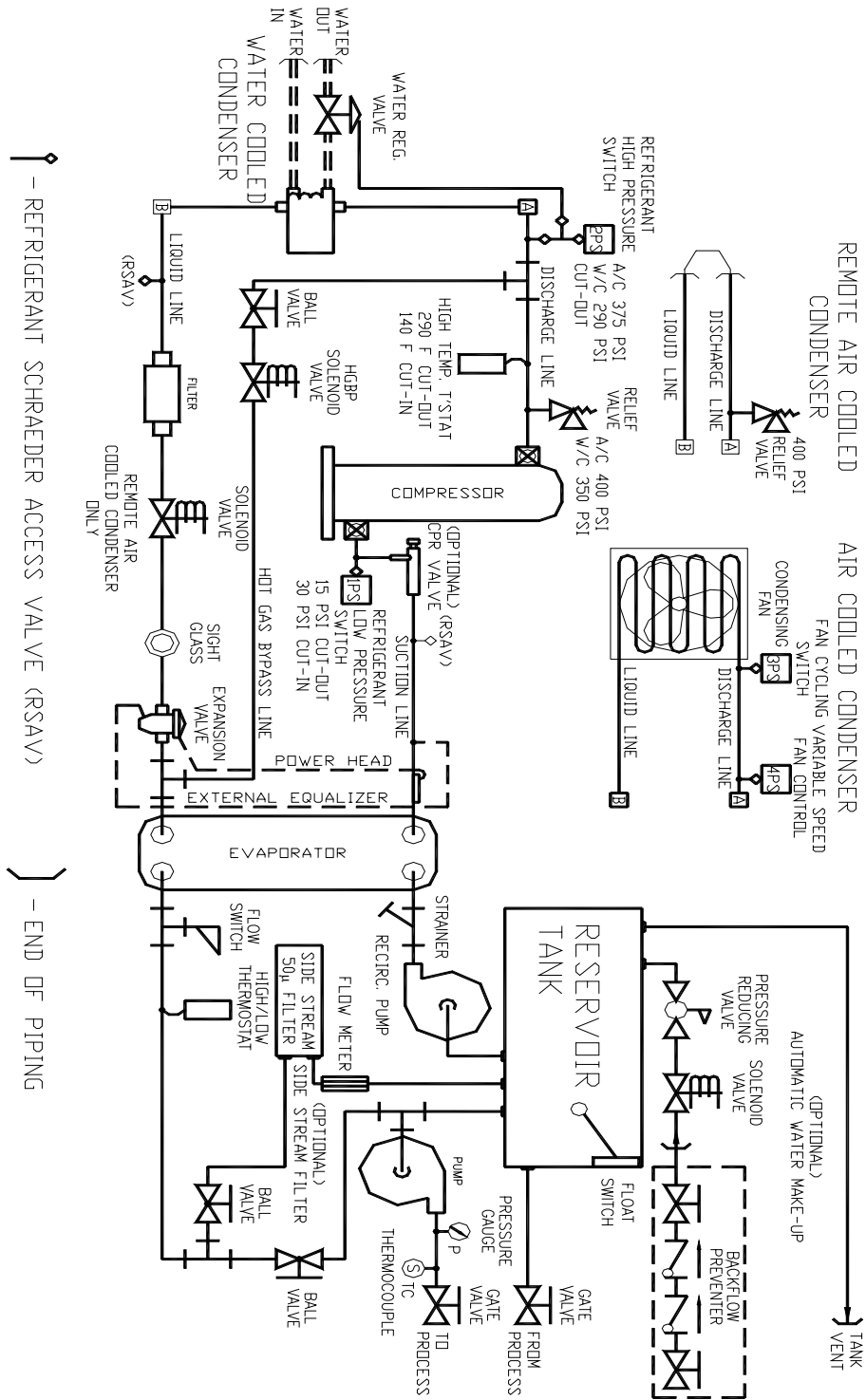

Typical Piping Schematic, 5 hp through 40 hp, No-Pump Models

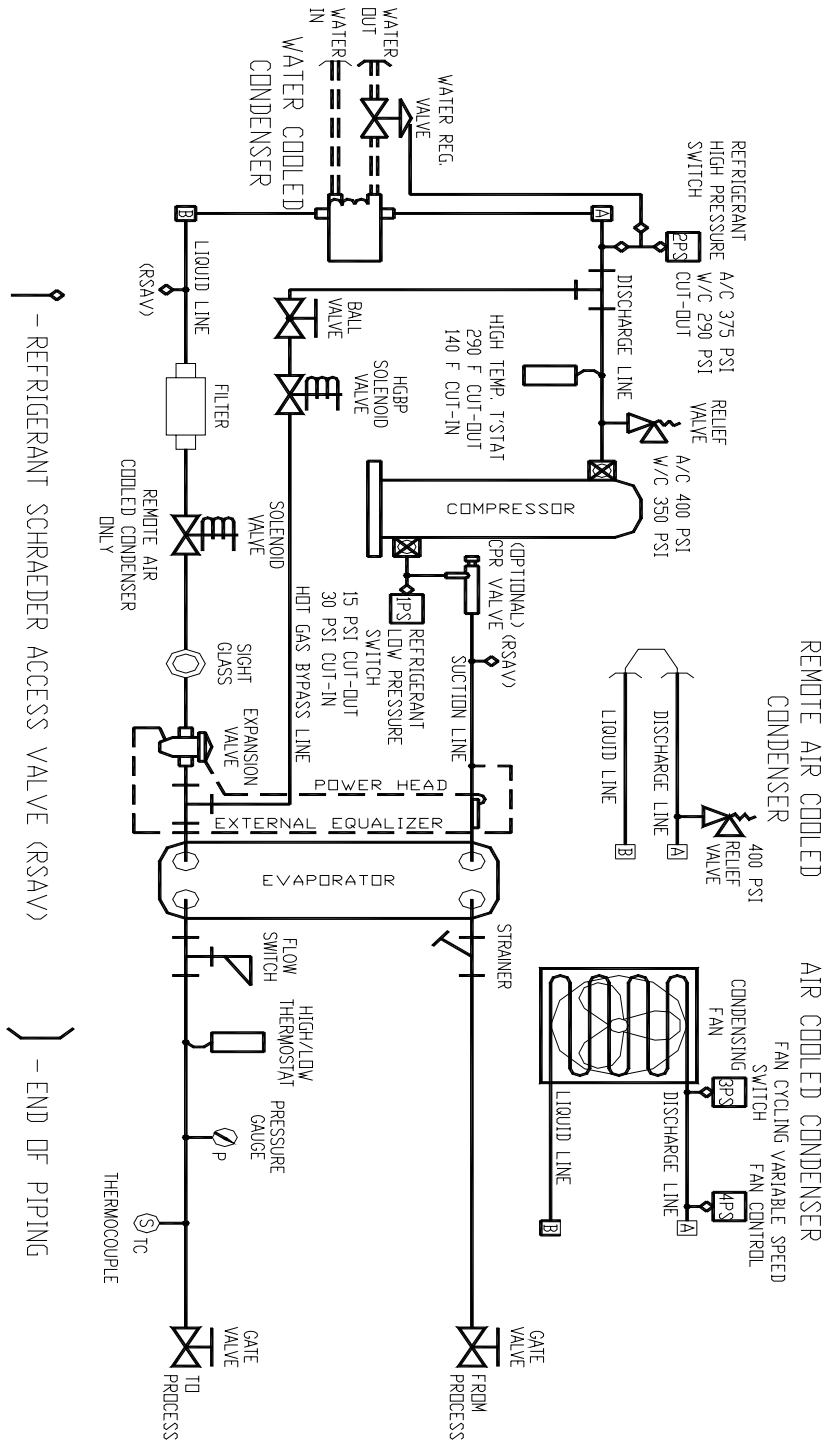

Typical Piping Schematic, 5 hp through 40 hp, One-Pump Models

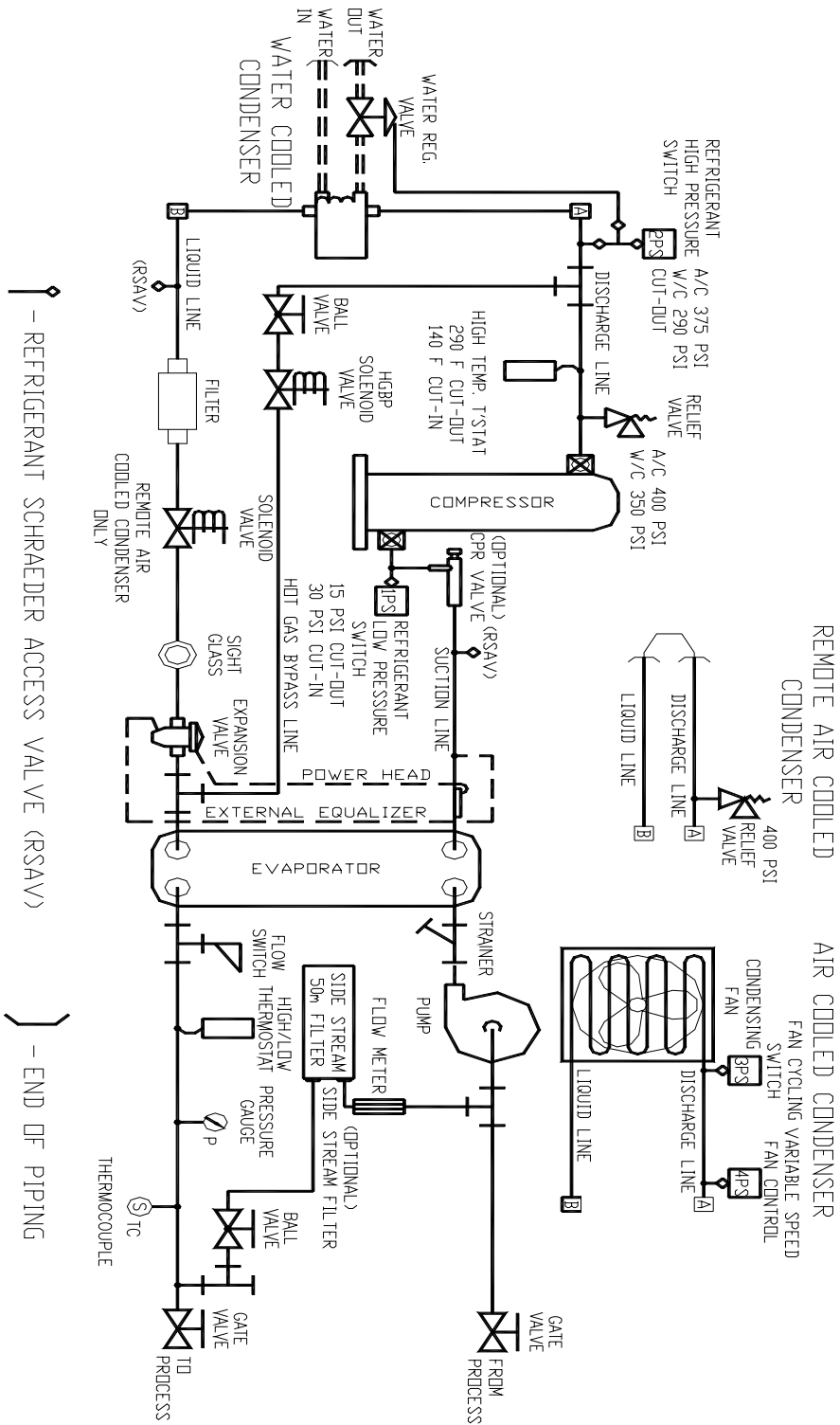

7-8 Electrical Schematics

Typical Electrical Subpanel

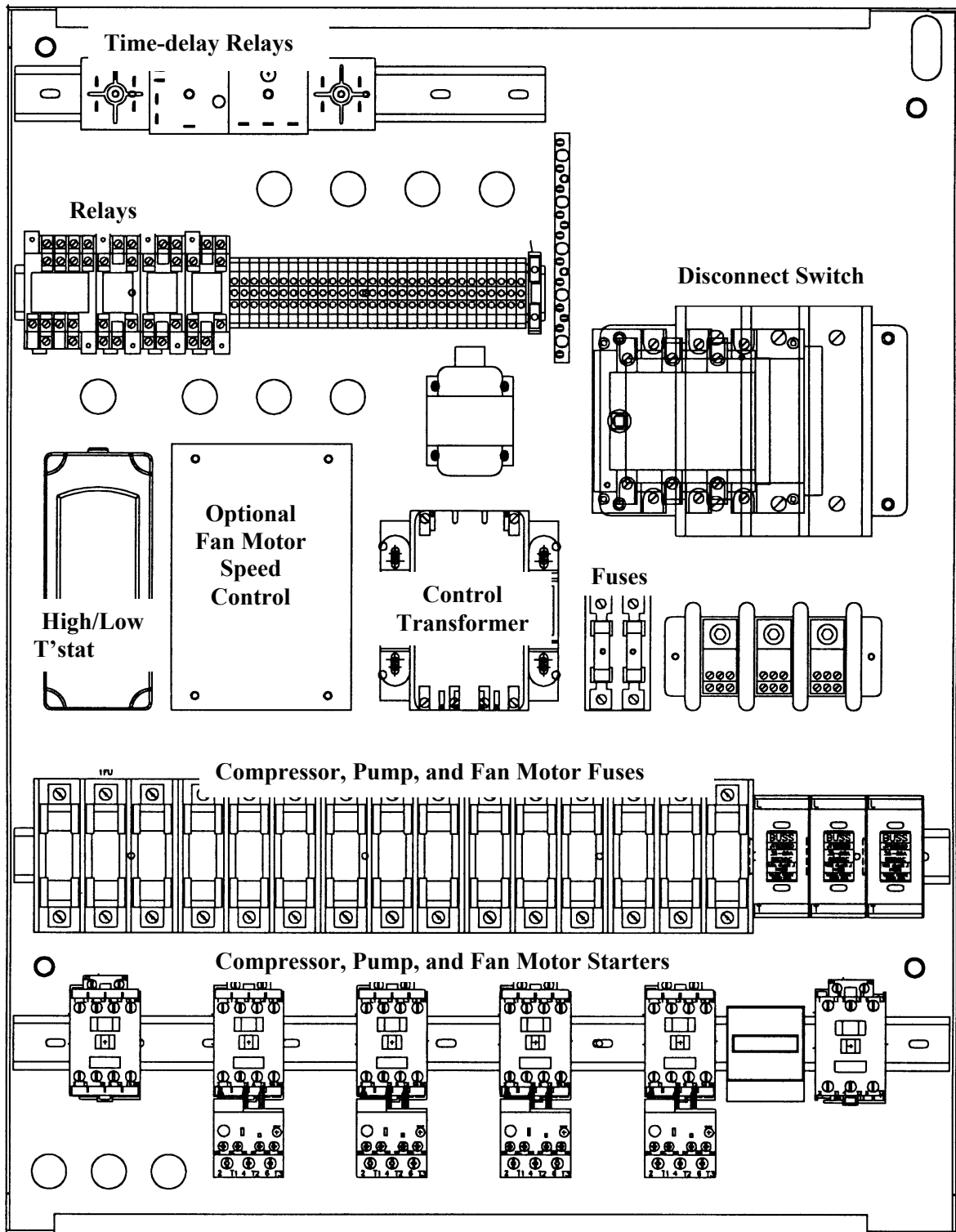

Typical Electrical Schematic, 2 hp and 3 1/2 hp Models

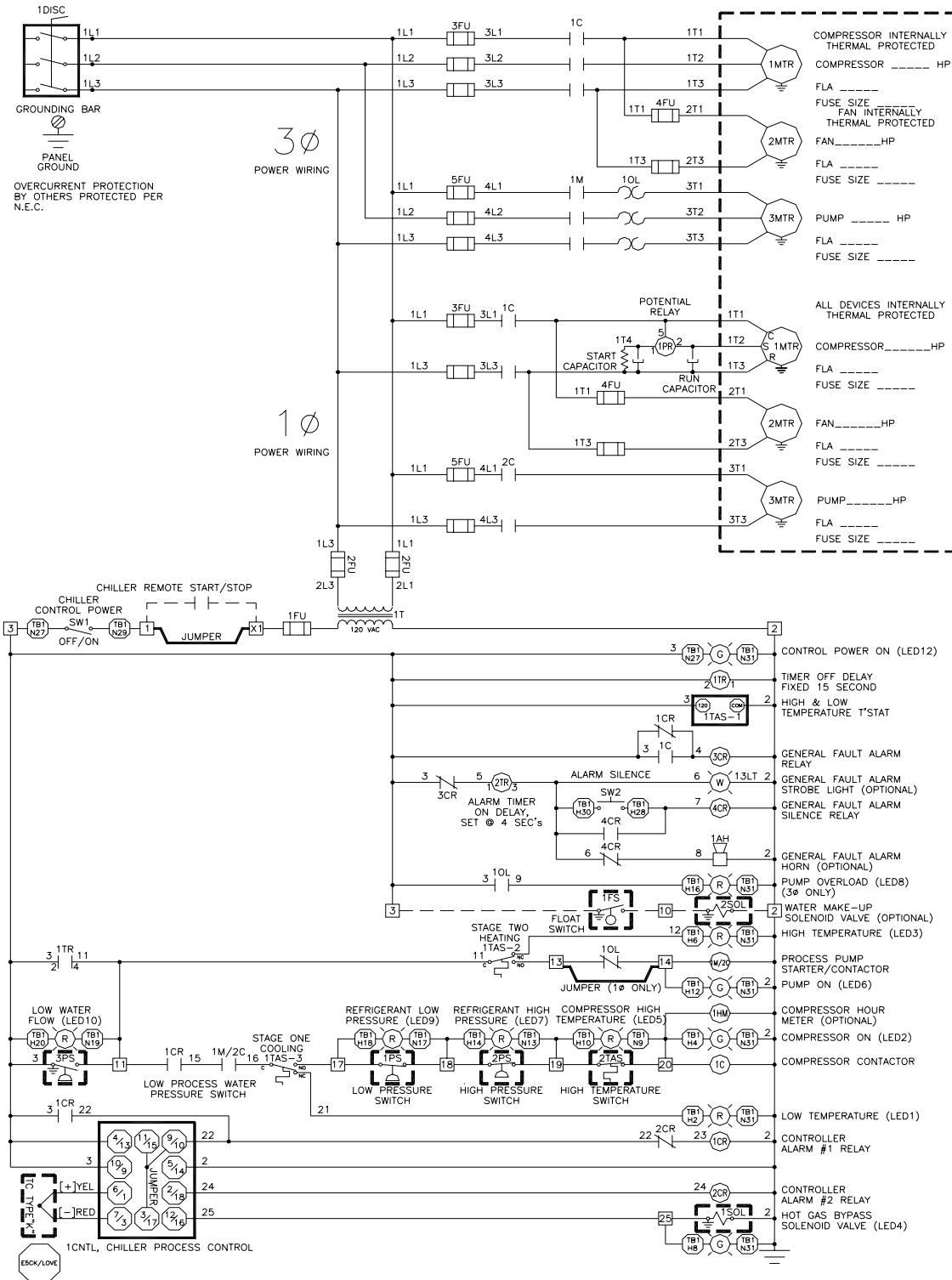

Typical Power Wiring Schematic, 5 hp through 40 hp Models

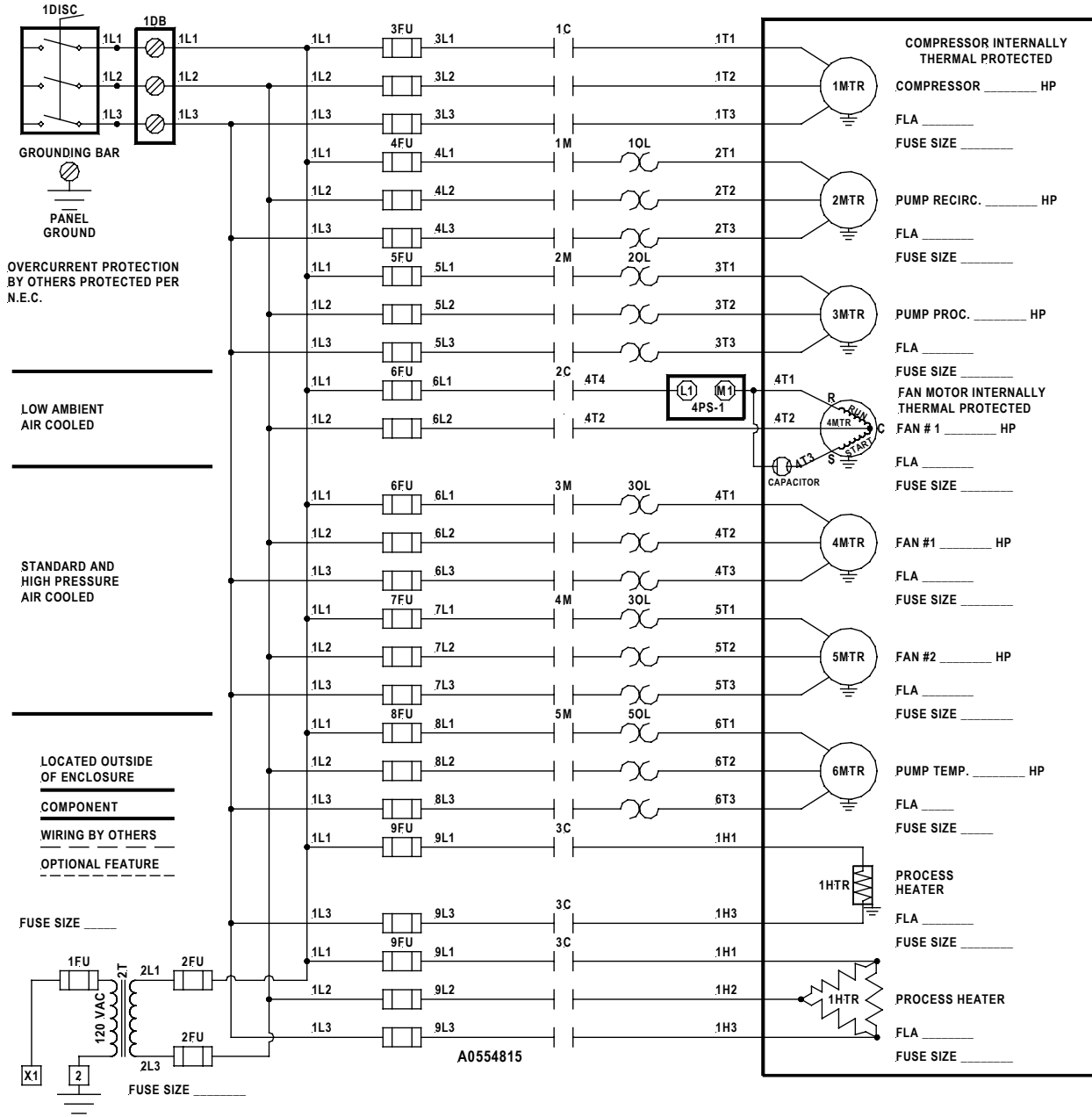

Typical Wiring Schematic, 5 hp through 15 hp Models with Pump

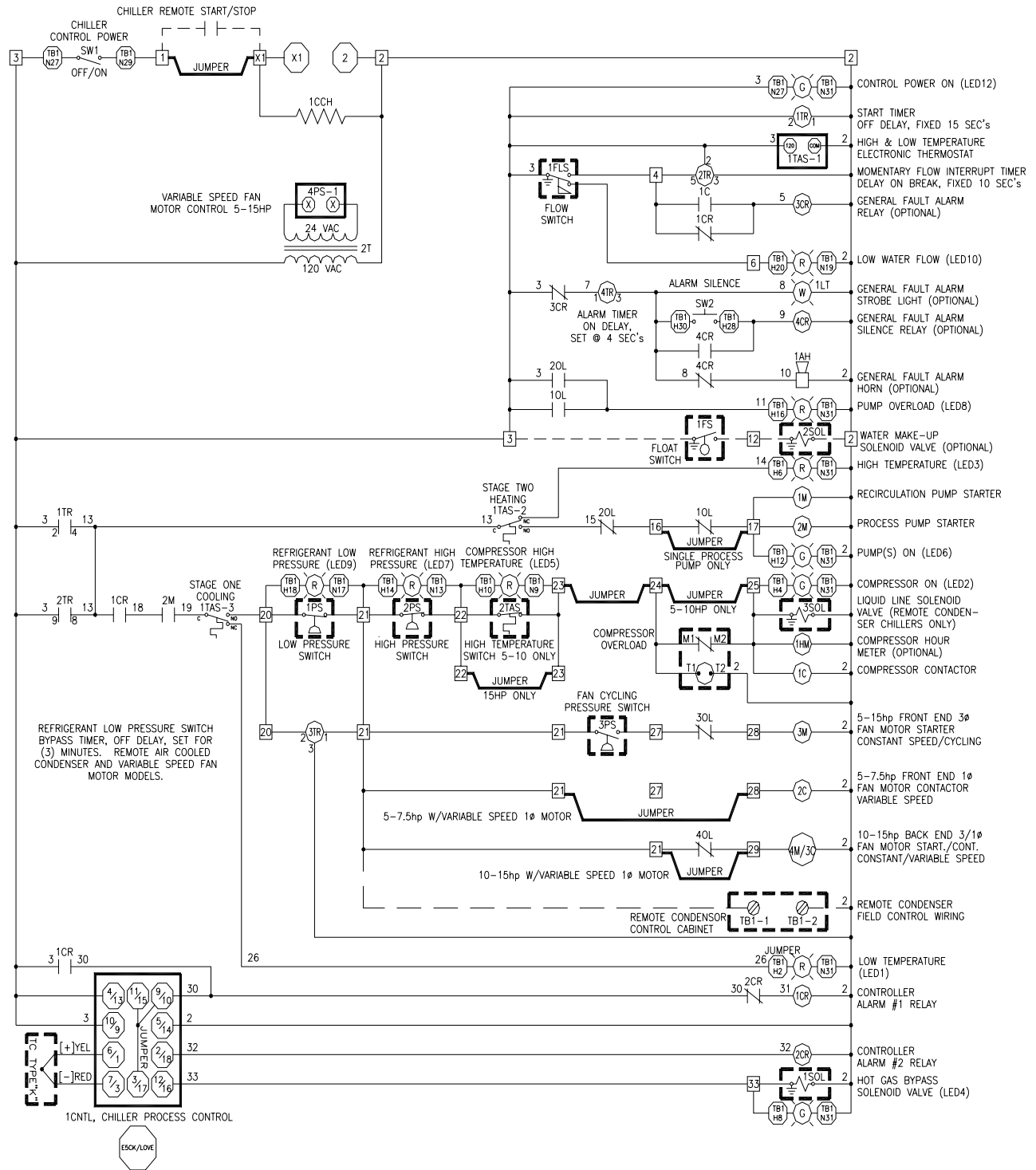

Typical Wiring Schematic, 5 hp through 15 hp Models without Pump

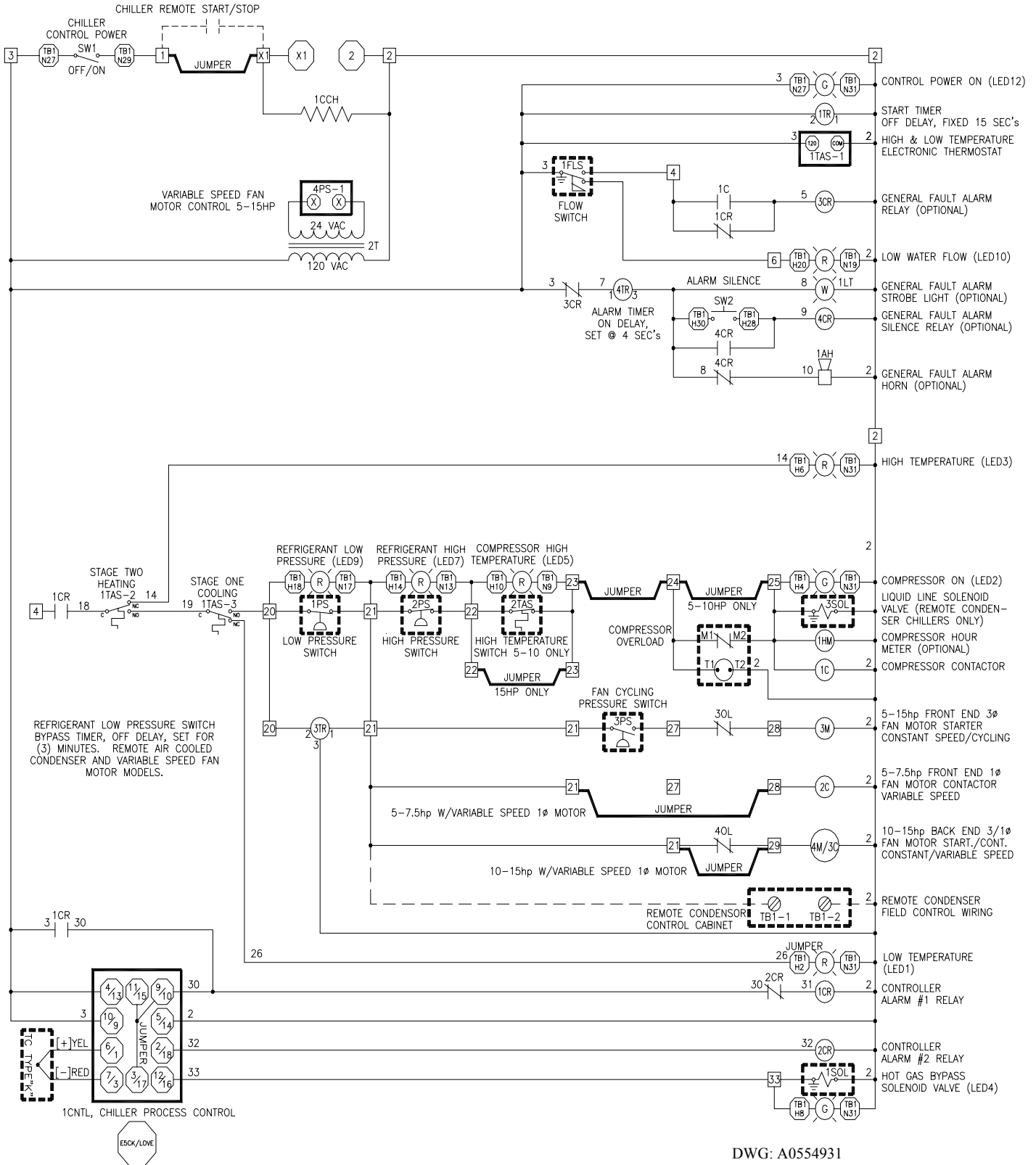

DWG: A0554931

Typical Wiring Schematic, 20 hp through 30 hp Models with Pump

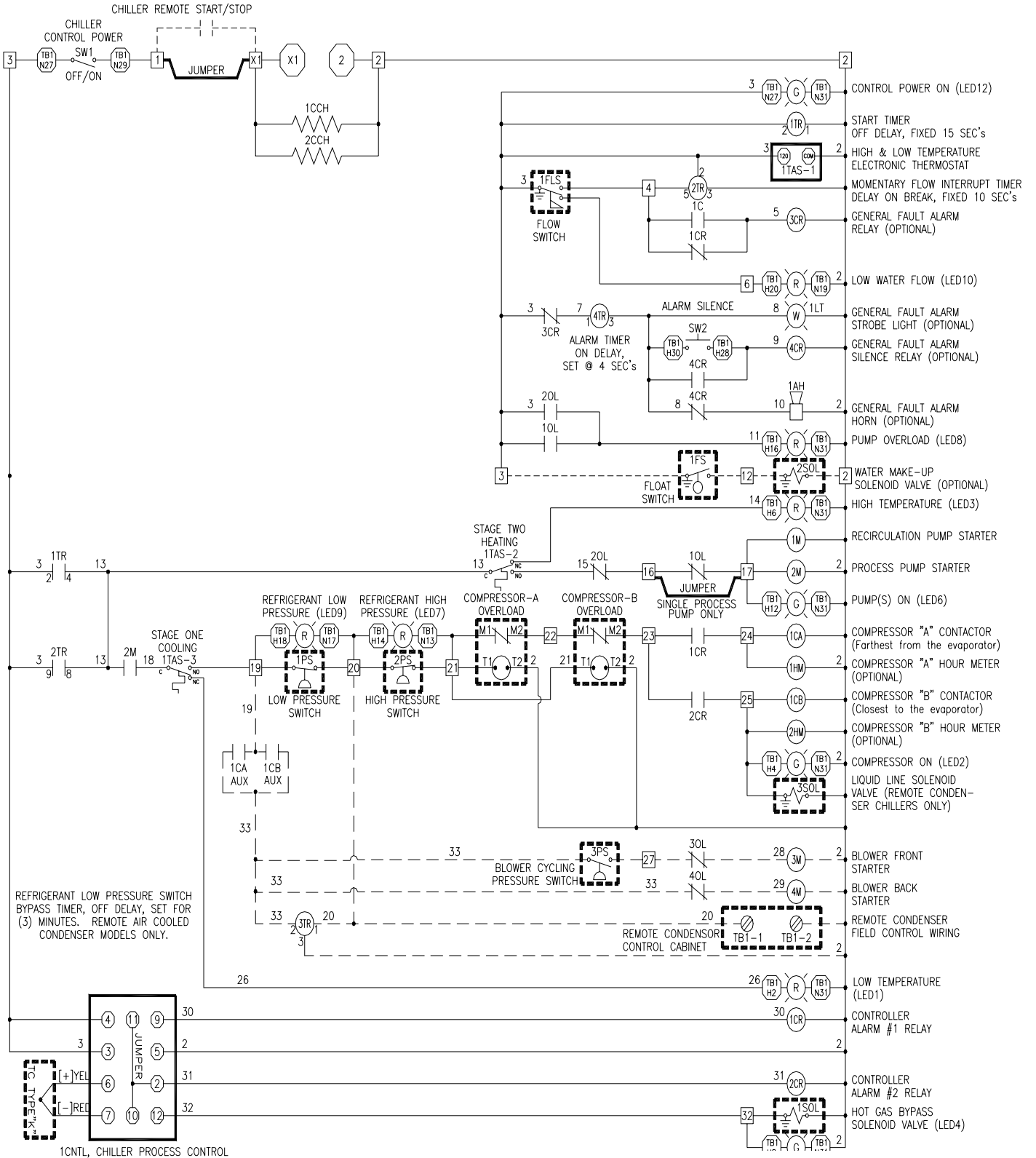

DWG: A0562343

Typical Wiring Schematic, 35 hp and 40 hp Models without Pump

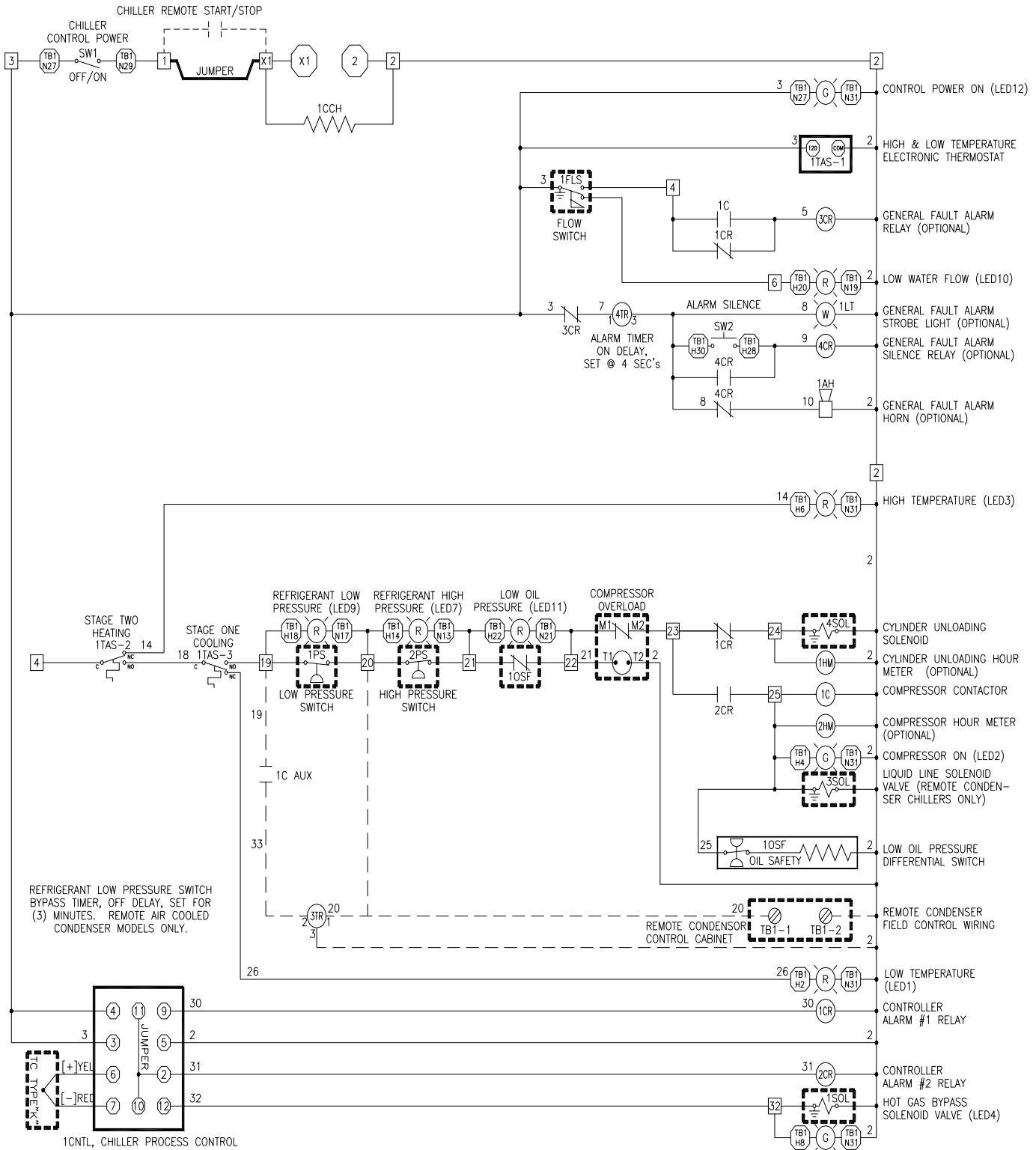

DWG: A0562434